

JVC

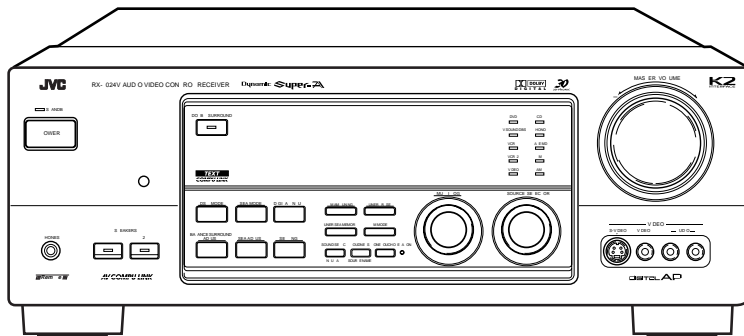

AUDIO/VIDEO CONTROL RECEIVER

RX-1024VBK



**TEXT
COMPU LINK**

**COMPU LINK
/// Remote ///**

AV COMPU LINK

K2 **3D**
INTERFACE 3D-PHONIC

DIGITAL AP

**DOLBY
DIGITAL**

INSTRUCTIONS

Dynamic **Super-A**

For Customer Use:

Enter below the Model No. and Serial No. which are located either on the rear, bottom or side of the cabinet. Retain this information for future reference.

Model No. _____

Serial No. _____

LVT0018-001A

[J]

Warnings, Cautions and Others

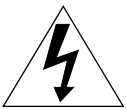

The lightning flash with arrowhead symbol, within an equilateral triangle is intended to alert the user to the presence of uninsulated "dangerous voltage" within the product's enclosure that may be of sufficient magnitude to constitute a risk of electric shock to persons.



The exclamation point within an equilateral triangle is intended to alert the user to the presence of important operating and maintenance (servicing) instructions in the literature accompanying the appliance.

CAUTION

To reduce the risk of electrical shocks, fire, etc.:

1. Do not remove screws, covers or cabinet.
2. Do not expose this appliance to rain or moisture.

Caution — POWER switch!

Disconnect the mains plug to shut the power off completely. The POWER switch in any position does not disconnect the mains line. The power can be remote controlled.

Caution — SPEAKER LOAD SELECTOR switch!

Match the position of SPEAKER LOAD SELECTOR switch on the back panel to the impedance of the speaker connected, to protect from overheating.

WARNING: TO REDUCE THE RISK OF FIRE OR ELECTRIC SHOCK, DO NOT EXPOSE THIS APPLIANCE TO RAIN OR MOISTURE.

To get the best DSP (Digital Signal Processor) effect in your listening room, note the speaker settings you have set on the table below for future reference (even though the receiver memorizes the settings until you change them).

For actual setting procedures, see pages 19 to 21.

Speakers	Setting		
Front Speakers	LARGE	SMALL	
Center Speaker	LARGE	SMALL	NONE
Rear Speaker	LARGE	SMALL	NONE
Center Delay	Set to [msec] (Select from 0 to 5 msec)		
Rear Delay	Set to [msec] (Select from 0 to 15 msec)		
Crossover Frequency	80 Hz	100 Hz	120 Hz
LFE Attenuator	0 dB	10 dB	
Dynamic Range Compression	OFF	MID	MAX

Note:

If the power cord is unplugged or a power failure occurs, all preset settings will be erased in a few days.

Table of Contents

Parts Identification	3
Getting Started	4
Before Installation	4
Checking the Supplied Accessories	4
Connecting the FM and AM Antennas	5
Connecting the Speakers	6
Connecting Audio/Video Components	8
Connecting the Power Cord	12
Putting Batteries in the Remote Control	12
Basic Operations	13
Turning the Power On and Off	13
Selecting the Source to Play	13
Adjusting the Volume	14
Selecting the Front Speakers	15
Muting the Sound	15
Using the Sleep Timer	15
Attenuating the Input Signal	16
Adjusting the Subwoofer Output Level	16
Recording a Source	16
Basic Settings	17
Changing the Source Name	17
Selecting the Input Mode	17
Adjusting the Front Speaker Output Balance	18
Setting the Subwoofer Information	18
Listening at Low Volume (Loudness)	18
Digital Input (DIGITAL IN) Terminal Setting	19
Setting the Speakers for the DSP Modes	19
One Touch Operation	22
About the One Touch Operation	22
Using the One Touch Operation	22
Receiving Radio Broadcasts	23
Tuning in Stations Manually	23
Using Preset Tuning	23
Selecting the FM Reception Mode	24
Assigning Names to Preset Stations	25
Using the SEA Modes	26
Selecting Your Favorite SEA Mode	26
Creating Your Own SEA Mode	27

Using the DSP Modes	28
Using the 3D-PHONIC Modes	29
Using the DAP Modes	32
Using the Dolby Digital and Dolby Pro Logic Modes	34
Using the Theater Surround Mode	37
Using the On-Screen Menus.....	41
Selecting the Source to Play	41
Selecting the Different Sources for Picture and Sound	41
Using the DSP Modes	41
Adjusting the Front Speaker Output Balance	42
Listening at Low Volume (Loudness)	42
Attenuating the Input Signal	42
Adjusting the Subwoofer Output Level	43
Adjusting the DSP Modes	43
Selecting Your Favorite SEA Mode	44
Creating Your Own SEA Mode	45
Basic Settings	45
Operating the Tuner	46
Storing the Preset Stations	46
Assigning Names to the Preset Stations	47
COMPU LINK Remote Control System	48
TEXT COMPU LINK Remote Control System.....	49
Showing the Disc Information on the TV Screen	50
Searching a Disc (Only for the CD Player)	51
Using the User File (Only for the CD Player with the User File Function)	53
Entering the Disc Information	54
AV COMPU LINK Remote Control System	56
Operating JVC's Audio/Video Components	58
Operating Other Manufactures' Components	62
Troubleshooting	68
Specifications	69

Parts Identification

Become familiar with the buttons and controls on the receiver before use.

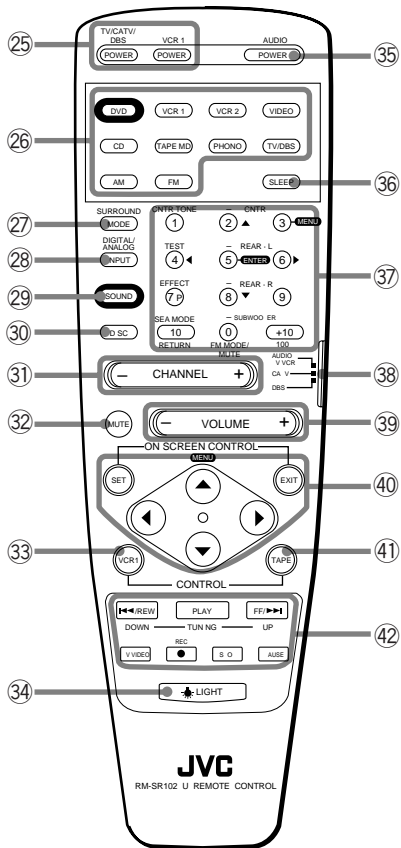
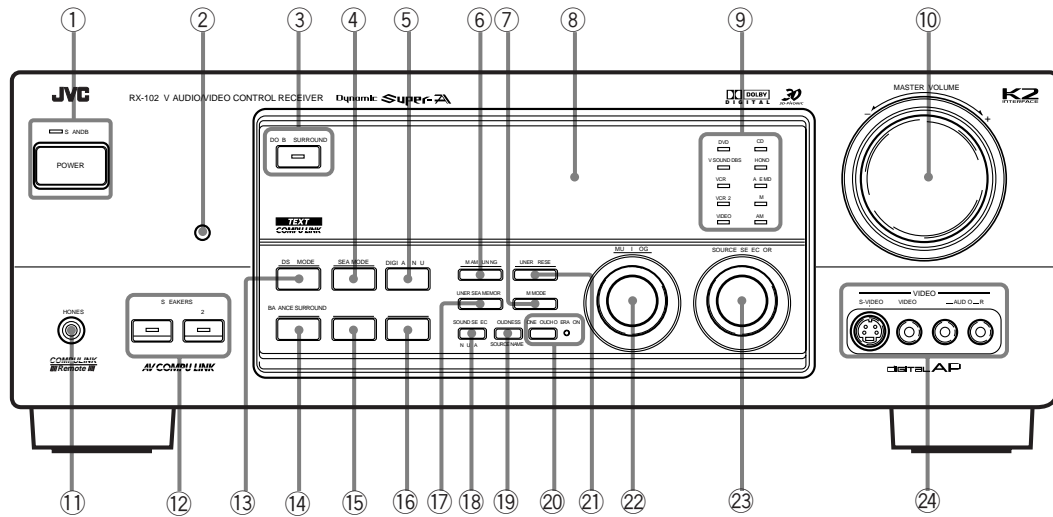

Refer to the pages in parentheses for details.

Front Panel

- ① POWER button and STANDBY lamp (13)
- ② Remote sensor (12)
- ③ DOLBY SURROUND button and lamp (36)
- ④ SEA MODE button (26) *
- ⑤ DIGITAL INPUT button (17)
- ⑥ FM/AM TUNING button (23) *
- ⑦ FM MODE button (24)
- ⑧ Display (13)
- ⑨ Source lamps (13)
- ⑩ MASTER VOLUME control (14)
- ⑪ PHONES jack (15)
- ⑫ SPEAKERS 1/2 buttons and lamps (15)
- ⑬ DSP MODE button (29) *
- ⑭ BALANCE/SURROUND ADJUST button (18, 30) *
- ⑮ SEA ADJUST button (27) *
- ⑯ SETTING button (18) *
- ⑰ TUNER/SEA MEMORY button (23, 25, 27)
- ⑱ SOUND SELECT/INPUT ATT. button (14, 16)
- ⑲ LOUDNESS/SOURCE NAME button (17, 18)
- ⑳ ONE TOUCH OPERATION button and lamp (22)
- ㉑ TUNER PRESET button (24) *
- ㉒ MULTI JOG control
- ⑳ SOURCE SELECTOR control (13)
- ㉔ VIDEO input jacks (10)

Remote Control

- ㉕ TV/CATV/DBS POWER and VCR1 POWER buttons (60, 61)
 - ㉖ Source selecting buttons (14)
 - ㉗ SURROUND MODE button (31)
 - ㉘ DIGITAL/ANALOG INPUT button (17)
 - ㉙ SOUND button (26, 31, 58)
 - ㉚ DISC button (59)
 - ㉛ CHANNEL buttons (+/-) (60, 62)
 - ㉜ MUTE button (15)
 - ㉝ VCR1 CONTROL button (60, 64)
 - ㉞ LIGHT button
 - ㉟ AUDIO POWER button (13)
 - ㊱ SLEEP button (15)
 - ㊲ 10 keys for selecting preset channel (24)
 - ㊳ 10 keys for adjusting sound (26, 31)
 - ㊴ 10 keys for operating audio/video components (58, 62)
 - ㊵ Remote control mode selector (AUDIO/TV/VCR, CATV, DBS) (13, 58, 62)
- To operate an audio system, TV, and VCR, set this selector to "AUDIO/TV/VCR."**
- To operate a CATV converter, set this selector to "CATV."**
- To operate a DBS tuner, set this selector to "DBS."**
- ㊶ VOLUME buttons (+/-) (14)
 - ㊷ MENU operating buttons (SET, EXIT, Δ, ▽, ◀, ▶) (41)
 - ㊸ TAPE CONTROL button (59)
 - ㊹ Operating buttons for audio/video components (58, 62)

When using the remote control in the dark

Press LIGHT (34).
The buttons on the remote control are backlit while you are using the remote control.
If you do not press any button for about 5 seconds, backlight will turn off.

Getting Started

This section explains how to connect audio/video components and speakers to the receiver, and how to connect the power supply.

Before Installation

General

- Be sure your hands are dry.
- Turn the power off to all components.
- Read the manuals supplied with the components you are going to connect.

Locations

- Install the receiver in a location that is level and protected from moisture.
- The temperature around the receiver must be between 23° and 95° F (–5° and 35° C).
- Make sure there is good ventilation around the receiver. Poor ventilation could cause overheating and damage the receiver.

Handling the receiver

- Do not insert any metal object into the receiver.
- Do not disassemble the receiver or remove screws, covers, or cabinet.
- Do not expose the receiver to rain or moisture.

Checking the Supplied Accessories

Check to be sure you have all of the following items, which are supplied with the receiver.

The number in the parentheses indicates quantity of the pieces supplied.

- **Remote Control (1)**
- **Batteries (2)**
- **AM Loop Antenna (1)**
- **FM Antenna (1)**

If anything is missing, contact your dealer immediately.

Getting Started

Connecting the FM and AM Antennas

FM Antenna Connections

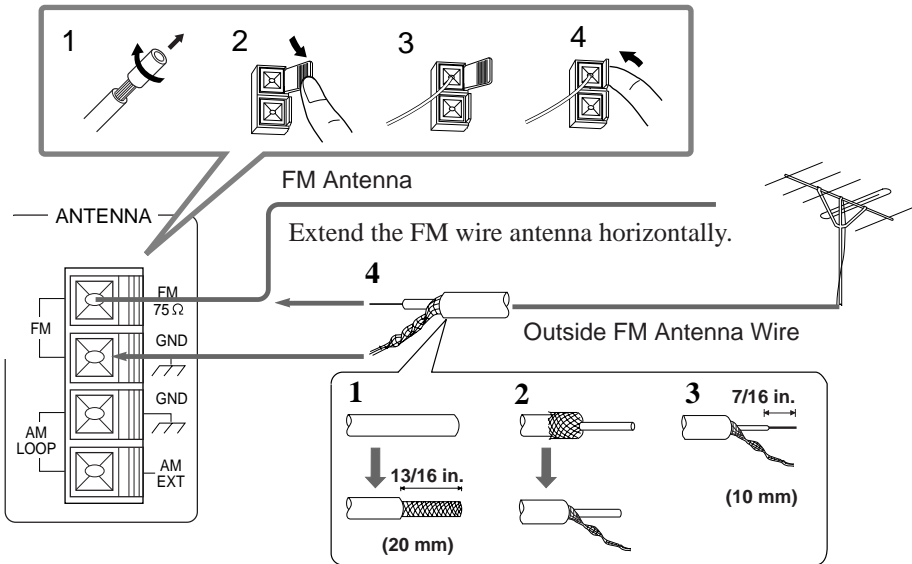

Note:

If reception is poor, connect the outside antenna. Before attaching a 75Ω coaxial cable (the kind with a round wire going to an outside antenna), disconnect the supplied FM wire antenna.

How to strip the 75Ω coaxial cable and connect it to the FM terminals

1. Strip back the outside covering of the 75Ω coaxial cable to expose the braided metallic mesh about 13/16 inches (20 mm).
2. Pull the mesh back and twist it into a single connector as shown in the illustration above.
3. Strip the insulation about 7/16 inches (10 mm) back from the central wire.
4. Insert the twisted mesh and the central wire to the FM terminals, as shown in the illustration above.

AM Antenna Connections

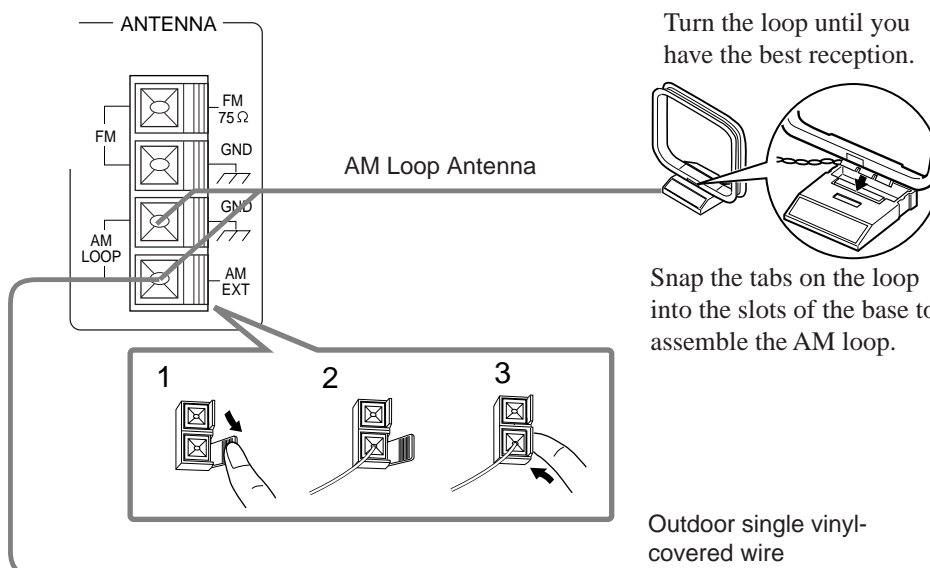

Notes:

- Make sure the antenna conductors do not touch any other terminals, connecting cords and power cord. This could cause poor reception.
- If reception is poor, connect an outdoor single vinyl-covered wire to the AM EXT terminal. (Keep the AM loop antenna connected.)

Connecting the Speakers

You can connect the following speakers:

- Two pairs of front speakers to produce normal stereo sound.
- One pair of rear speakers to enjoy the surround effect.
- One center speaker to produce more effective surround effect (to emphasize human voices).
- One subwoofer to enhance the bass.

IMPORTANT:

After connecting the speakers listed above, set the speaker setting information properly to obtain the best possible performance. For details, see pages 18 and 19.

For each speaker (except for subwoofer), connect the (-) and (+) terminals on the rear panel to the (-) and (+) terminals marked on the speakers. For connecting a subwoofer, see page 7.

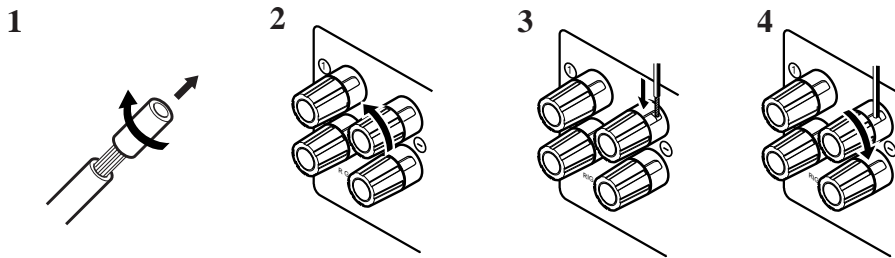

- 1 Cut, twist and remove the insulation at the end of each speaker signal cable.
- 2 Turn the knob counterclockwise.
- 3 Insert the speaker signal cable.
- 4 Turn the knob clockwise.

Connecting the front speakers

Connect the front speakers to the FRONT SPEAKERS terminals.

You can connect two pairs of front speakers (one pair to the FRONT SPEAKERS ① terminals, and another pair to the FRONT SPEAKERS ② terminals).

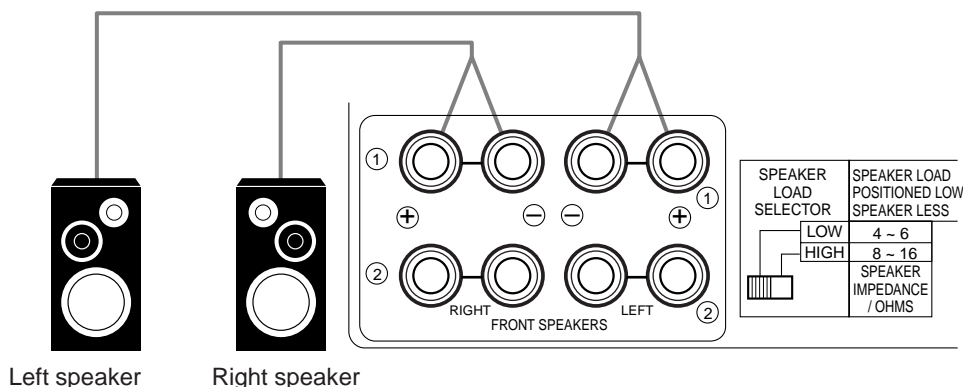

CAUTION:

Use speakers with the **SPEAKER IMPEDANCE** indicated by the speaker terminals.

Note:

To obtain the best possible output power from the receiver, and to prevent the receiver from being overheated, the receiver has the **SPEAKER LOAD SELECTOR** which has to be set as follows:

- Set it to the **HIGH** position when the impedance of the speakers connected is within the range of 8 ohms to 16 ohms.
- Set it to the **LOW** position when the impedance of the speakers connected is within the range of 4 ohms to 6 ohms.
- Set it to the **LOW** position when the impedance of the any speaker connected is 6 ohms or less.

Getting Started

Connecting the rear and center speakers

Connect the rear speakers to the REAR SPEAKERS terminals and a center speaker to the CENTER SPEAKER terminals.

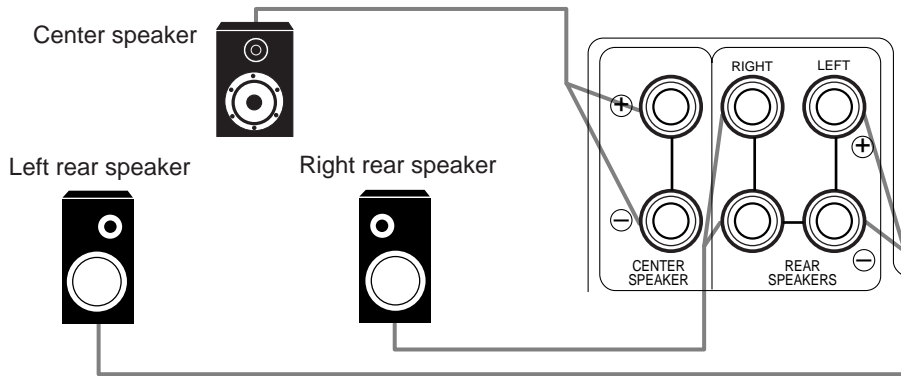

Connecting the subwoofer speaker

Connect the input jack of a powered subwoofer to the SUBWOOFER jack on the rear panel, using a cable with RCA pin plugs.

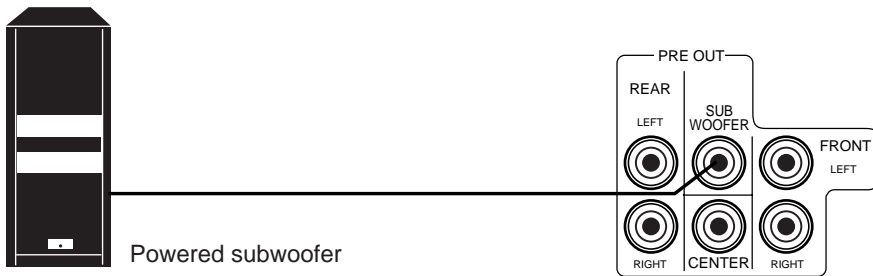

To enhance your audio system

You can use this receiver as the pre-amplifier (control amplifier) when you connect power amplifiers to the PRE OUT jacks on the rear panel, using cables with RCA pin plugs.

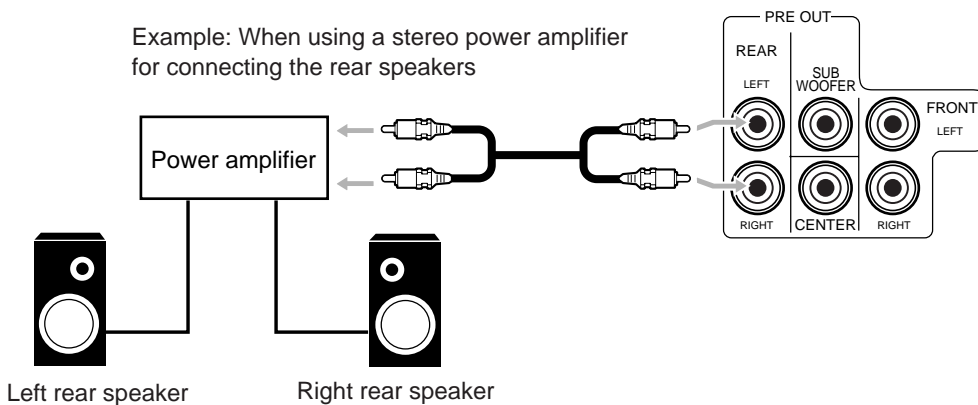

CAUTION:

Use speakers with the SPEAKER IMPEDANCE indicated by the speaker terminals.

Note:

To obtain the best possible output power from the receiver, and to prevent the receiver from being overheated, the receiver has the SPEAKER LOAD SELECTOR which has to be set as follows:

- Set it to the HIGH position when the impedance of the speakers connected is within the range of 8 ohms to 16 ohms.
- Set it to the LOW position when the impedance of the speakers connected is within the range of 4 ohms to 6 ohms.
- Set it to the LOW position when the impedance of the any speaker connected is 6 ohms or less.

Connecting Audio/Video Components

You can connect the following audio/video components to this receiver. Refer also to the manuals supplied with your components. If you want to connect a component not listed in the table below, refer to the manual supplied with it.

Audio Components	Video Components
• Turntable	• DVD player*
• CD player*	• TV
• Cassette deck or MD recorder*	• DBS tuner*
_____	• VCRs
_____	• Video camera

* You can connect these components using the methods described in "Analog connections" (below) or in "Digital connections" (see page 11).

Analog connections

Audio component connections

Use the cables with RCA pin plugs (not supplied).
Connect the white plug to the audio left jack, and the red plug to the audio right jack.

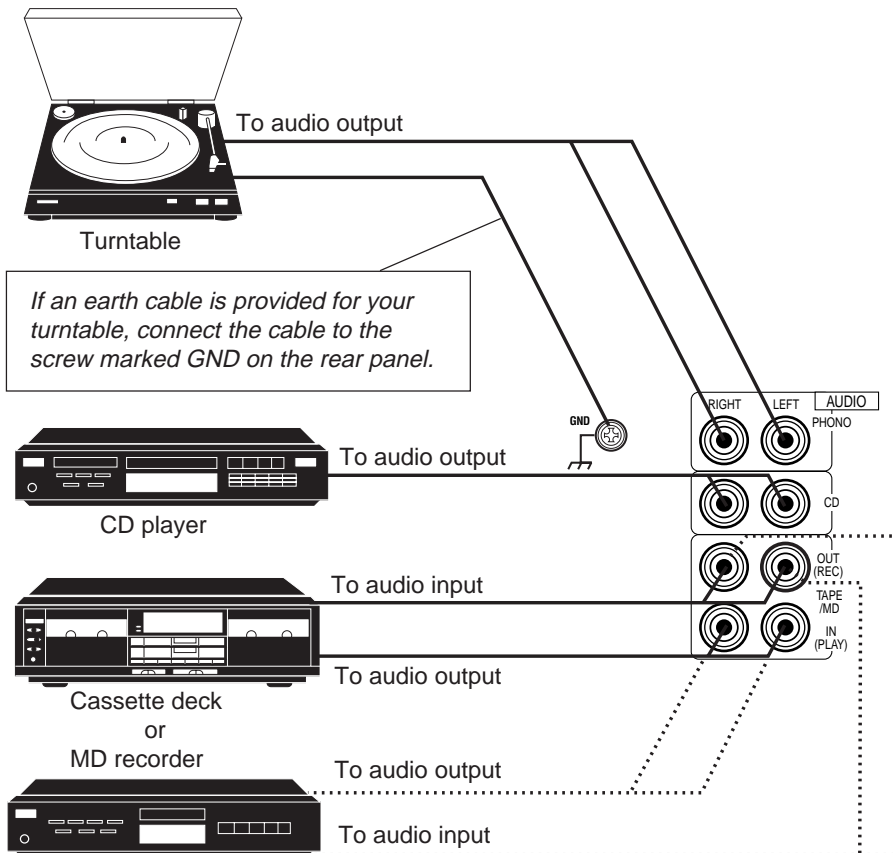

If your audio components have a COMPU LINK-3 or TEXT COMPU LINK terminal

- See also page 48 for detailed information about the connection and the COMPU LINK-3 remote control system.
- See also page 49 for detailed information about the connection and the TEXT COMPU LINK remote control system.

CAUTION:

If you connect a sound-enhancing device such as a graphic equalizer between the source components and this receiver, the sound output through this receiver may be distorted.

Notes:

- Any turntables incorporating a small-output cartridge such as an MC (moving-coil type) must be connected to this receiver through a commercial head amplifier or step-up transformer. Direct connection may result in insufficient volume.
- You can connect either a cassette deck or an MD recorder to the TAPE/MD jacks. When connecting an MD recorder to the TAPE/MD jacks, change the source name, which will be shown on the display when selected as the source, to "MD." See page 17 for details.

Getting Started

Video component connections

Use the cables with RCA pin plugs (not supplied).

Connect the white plug to the audio left jack, the red plug to the audio right jack, and the yellow plug to the video jack.

If your video components have S-video (Y/C-separation) terminals, connect them using S-video cables (not supplied). Connecting these video components through the S-video input/output terminals will give you better picture playback (or recording) quality.

IMPORTANT:

This receiver is equipped with both the composite video and S-video input/output terminals for connecting video components.

You do not have to connect both the composite video and S-video terminals.

However, **remember that the video signals from the composite video input terminals are output only through the composite video output terminals, while the ones from the S-video input terminals are output only through the S-video output terminals.**

Therefore, if a recording video component and a playing video component are connected to the receiver through the different video terminals, you cannot record the picture from the playing component on the recording component. In addition, if the TV and a playing video component are connected to the receiver through the different video terminals, you cannot view the playback picture from the playing component on the TV.

To view and record the playback picture from the video component connected to the VCR 2 jacks, you must connect the TV and the recording video component through the composite video terminals.

Connecting the TV and/or DBS tuner

You can connect either the TV or DBS tuner to the TV SOUND/DBS jacks.

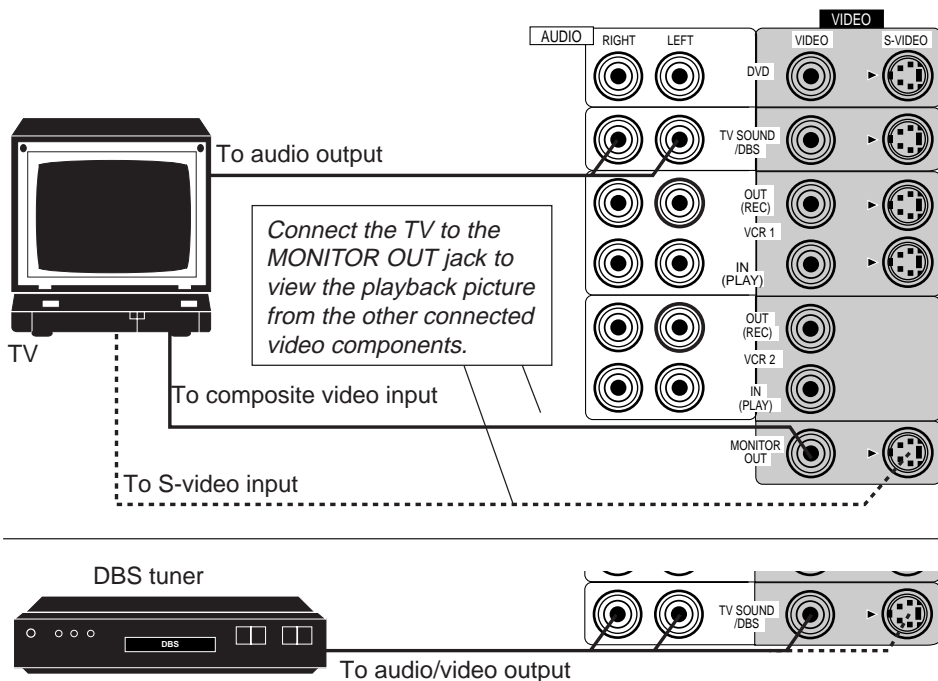

Notes:

- When connecting the TV to the TV SOUND/DBS jacks, DO NOT connect the TV's video output to these video input terminals.
- When connecting the DBS tuner to the TV SOUND/DBS jacks, change the source name, which will be shown on the display when selected as the source, to "DBS." See page 17 for details.
- To enjoy Dolby Digital with the DBS tuner as the source, connect the DBS tuner using the method described in "Digital connections" on page 11.

Connecting DVD player

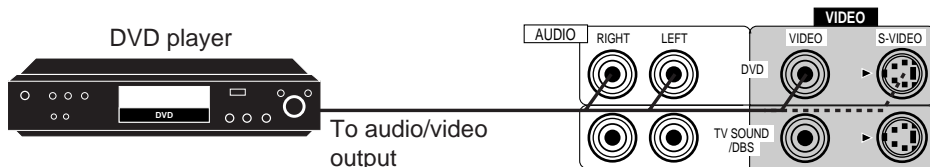

Note:

To enjoy Dolby Digital with the DVD player as the source, connect the DVD player, using the method described in "Digital connections" on page 11.

Connecting VCRs

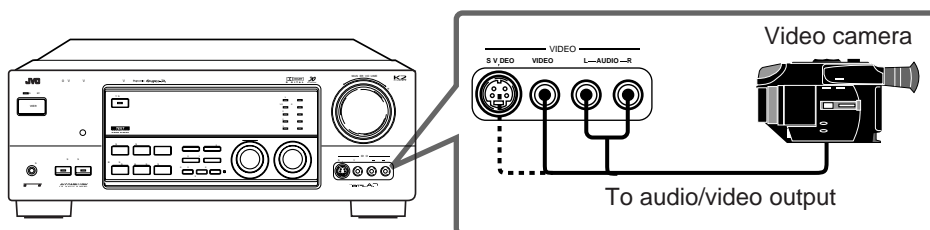
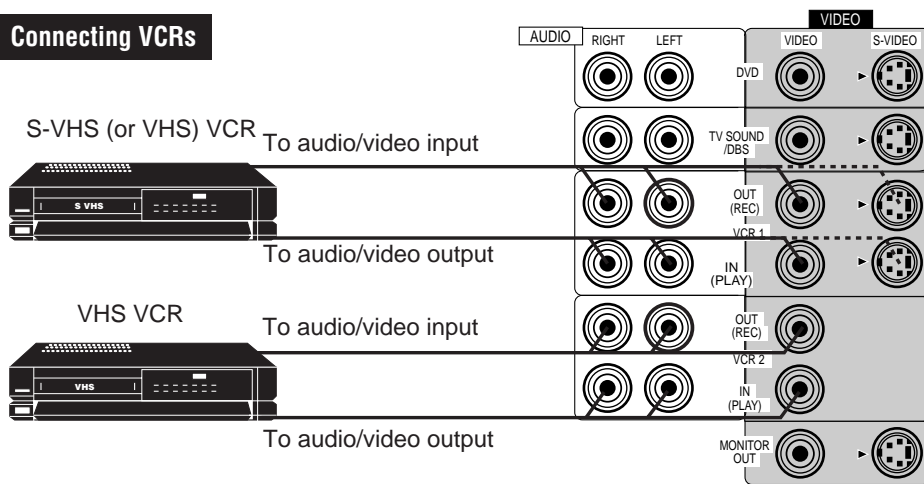

If your video components have an AV COMPU LINK terminal

See also page 56 for detailed information about the connection and the AV COMPU LINK remote control system.

Getting Started

Digital connections

This receiver is equipped with three DIGITAL IN terminals — one digital coaxial terminal and two digital optical terminals.

To enjoy Dolby Digital, you have to connect the source components using the DIGITAL IN terminals.

You can connect any component to any one of the digital terminals using the digital coaxial cable (not supplied) or digital optical cable (not supplied).

DBS tuner



DVD player



CD player



MD recorder



When the component has a digital coaxial output terminal, connect it to the DIGITAL1 (DBS) terminal, using the digital coaxial cable (not supplied).

When the component has a digital optical output terminal, connect it to the DIGITAL2 (DVD) or DIGITAL3 (CD) terminal, using the digital optical cable (not supplied).

Before connecting a digital optical cable, unplug the protective plug.

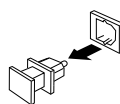

Notes:

- When shipped from the factory, the DIGITAL IN terminals has been set for use with the following components.
 - DIGITAL 1 (coaxial): For DBS tuner
 - DIGITAL 2 (optical): For DVD player
 - DIGITAL 3 (optical): For CD player
- When you want to operate the CD player or MD recorder using the COMPU LINK remote control system, connect the target component also as described in “Analog connections” (see page 8).

IMPORTANT:

- When connecting the DVD player or the DBS tuner using the digital terminal, you also need to connect it to the video jack (either composite video terminal or S-video terminal) on the rear. Without connecting it to the video jack, you can view no playback picture.
- After connecting the above components using the DIGITAL IN terminals, set the following correctly if necessary.
 - Select the digital input mode correctly. For details, see “Selecting the Input Mode” on page 17.
 - Set the digital input (DIGITAL IN) terminal setting correctly. For details, see “Digital Input (DIGITAL IN) Terminal Setting” on page 19.

Connecting the Power Cord

Before plugging the receiver into an AC outlet, make sure that all connections have been made.

When the power cord is connected, the STANDBY lamp above the POWER button lights up.

Keep the power cord away from the connecting cables and antenna. The power cord may cause noise or screen interference. We recommend that you use a coaxial cable to connect the antenna, since it is well-shielded against interference.

Notes:

- A small amount of power is always consumed even in standby mode. To switch off the power completely, unplug the power cord from the AC outlet.
- If the power cord is unplugged or a power failure occurs, preset settings will be erased in a few days.

CAUTIONS:

- Do not touch the power cord with wet hands.
- Do not pull on the power cord to unplug the cord. When unplugging the cord, always grasp the plug so as not to damage the cord.

Putting Batteries in the Remote Control

Before using the remote control, put two supplied batteries first. When using the remote control, aim the remote control directly at the remote sensor on the receiver.

1. On the back of the remote control, remove the battery cover as illustrated.
2. Insert batteries. Make sure to observe the proper polarity: (+) to (+) and (-) to (-).
3. Replace the cover.

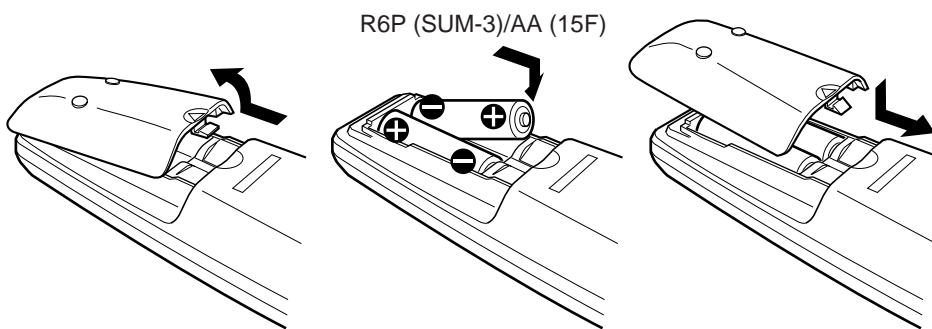

If the range or effectiveness of the remote control decreases, replace the batteries. Use two R6P (SUM-3)/AA (15F) type dry-cell batteries.

CAUTION:

- Follow these precautions to avoid leaking or cracking cells:
- Place batteries in the remote control so they match the polarity indicated: (+) to (+) and (-) to (-).
 - Use the correct type of batteries. Batteries that look similar may differ in voltage.
 - Always replace both batteries at the same time.
 - Do not expose batteries to heat or flame.

Basic Operations

The following operations are commonly used when you play any sound source.

IMPORTANT:

When using the Remote Control, check to see if its remote control mode selector is set to the correct position:

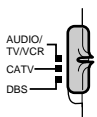

To operate an audio system, TV, and VCR, set it to "AUDIO/TV/VCR."

To operate a CATV converter, set it to "CATV."

To operate a DBS tuner, set it to "DBS."

Turning the Power On and Off

On the front panel:

To turn on the power, press POWER.

The STANDBY lamp goes off. The name of the current source (or station frequency) appears on the display.

- When the TV is connected to the TV SOUND/DBS jacks on the rear: The receiver automatically turns on and select "TV SOUND" as the source about 5 seconds after you turn on the TV. (If you change the source name from "TV SOUND" to "DBS," the receiver will not turn on along with the TV. See page 17) Current source name appears

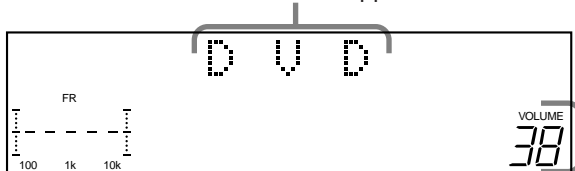

Current volume level is shown here

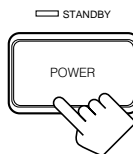

To turn off the power, press POWER again.

The STANDBY lamp lights up.

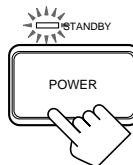

From the remote control:

To turn on the power, press AUDIO POWER.

The STANDBY lamp goes off. The name of the current source (or station frequency) appears on the display.

To turn off the power, press AUDIO POWER again.

The STANDBY lamp lights up.

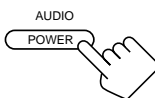

Selecting the Source to Play

On the front panel:

Turn SOURCE SELECTOR until the source name you want appears on the display.

As you turn the selector, the source changes as follows:



The selected source lamp also lights up.

Selected source name appears

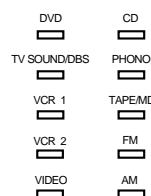
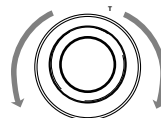
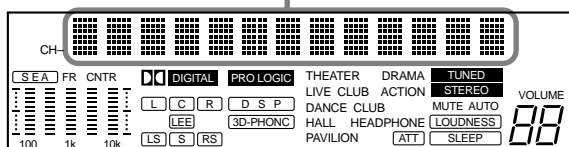

Source lamps on the front panel

What are the following indicators?

When you select the source encoded with Dolby Digital and start playback, the following indicators light up on the display to show the signal being input to this receiver. (Only the indicators for the received signals light up.)

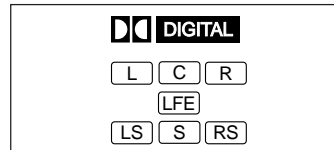

- L: Left front channel
- R: Right front channel
- C: Center channel
- LS: Left rear channel
- RS: Right rear channel
- S: Rear channel (monaural)
- LFE: Subwoofer channel

Note:

When you turn off the receiver with the TV kept turned on, the receiver will turn on soon again. To prevent this from happening, make sure that you turn off the TV before turning off the receiver.

Note:

When connecting an MD recorder (to the TAPE/MD jacks), and a DBS tuner (to the TV SOUND/DBS jacks), change the source name appears on the display. For details, see page 17.

From the remote control:

Press one of the source selecting buttons directly.

DVD	Selects the DVD player.
VCR1	Selects the video component connected to the VCR1 jacks.
VCR2	Selects the video component connected to the VCR2 jacks.
VIDEO	Selects the video component connected to the VIDEO jacks.
CD*	Selects the CD player.
TAPE/MD*	Selects the cassette deck or the MD recorder.
PHONO*	Selects the turntable.
FM*	Selects an FM broadcast.
AM*	Selects an AM broadcast.
TV/DBS	<ul style="list-style-type: none">• Selects TV sounds when the remote control selector is set to "AUDIO/TV/VCR."• Selects the DBS tuner when the remote control selector is set to "DBS."

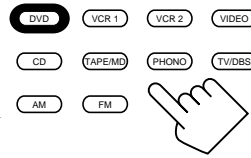

Note:

When you press one of the source selecting buttons marked above with an asterisk (*), the receiver automatically turns on.

Selecting different sources for picture and sound

You can watch picture from a video component while listening to sound from another component.

On the front panel:

1. Press SOUND SELECT briefly while viewing the picture from a video component such as the VCR or DVD player, etc. "SOUND SELECT" appears on the display.
2. Turn SOURCE SELECTOR to select the sound (except the TV sound), while the indication of the above step is still on the display.

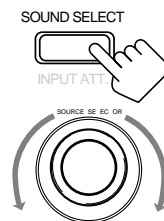

From the remote control:

Press one of the audio source selecting buttons (CD, TAPE/MD, PHONO, FM, AM), while viewing the picture from a video component such as the VCR or DVD player, etc.

Adjusting the Volume

On the front panel:

To increase the volume, turn MASTER VOLUME clockwise.
To decrease the volume, turn it counterclockwise.

When you turn MASTER VOLUME **rapidly**, the volume level also changes **rapidly**.
When you turn MASTER VOLUME **slowly**, the volume level also changes **slowly**.

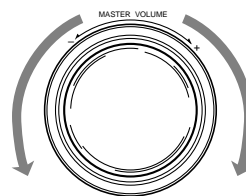

From the remote control:

To increase the volume, press VOLUME +.
To decrease the volume, press VOLUME -.

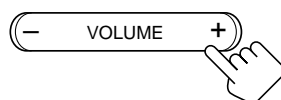

Notes:

- Once you have selected a video source, pictures of the selected source is sent to the TV until you select another video source.
- When you select TV sound as the source, this function does not work.

CAUTION:

Always set the volume to the minimum before starting any source. If the volume is set at its high level, the sudden blast of sound energy can permanently damage your hearing and/or ruin your speakers.

Note:

The volume level can be adjusted within the range of "0" (minimum) to "90" (maximum).

Basic Operations

Selecting the Front Speakers

On the front panel *only*:

When you have connected two pairs of the front speakers, you can select which to use.

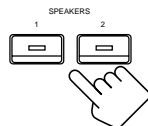

Press **SPEAKERS 1** or **SPEAKERS 2** to select the speaker to use.

Each time you press the button, the lamp on the respective button turns on and off. When the lamp on either button lights up, the respective speakers are activated.

IMPORTANT:

You can activate two pairs of the front speakers at the same time only when the **SPEAKER LOAD SELECTOR** on the rear panel is set to “HIGH” and when no signals are sent to the center and rear speakers. Otherwise, activating one pair of the speakers deactivates the other.

Listening only with headphones

1. Connect a pair of headphones to the **PHONES** jack on the front panel.
2. Press **SPEAKERS 1** and/or **2** so that no lamps on the buttons are turned on.

Muting the Sound

From the remote control *only*:

Press **MUTE** to mute the sound through all speakers and headphones connected.

“MUTE” appears on the display and the volume turns off (the volume level indicator also goes off).



To restore the sound, press **MUTE** again so that “OFF” appears on the display. Turning **MASTER VOLUME** or pressing **VOLUME +/-** also restores the sound at the previous volume level.

Using the Sleep Timer

Using the Sleep Timer, you can fall asleep to music and know the receiver will turn off by itself rather than play all night.

From the remote control *only*:

Press **SLEEP** repeatedly.

The **SLEEP** indicator lights up on the display, and the shut-off time on the display changes as follows.

- SLEEP 10min. → SLEEP 20min. → SLEEP 30min. → SLEEP 40min.
- SLEEP 50min. → SLEEP 60min. → SLEEP 70min. → SLEEP 80min.
- SLEEP 90min. → SLEEP 00min. (Canceled) → (back to the beginning)



When the shut-off time comes

The receiver turns off automatically.

To check or change the time remaining until the shut-off time

Press **SLEEP** once. The remaining time until the shut-off time appears in minutes.

- To change the shut-off time, press **SLEEP** repeatedly.

To cancel the Sleep Timer

Press **SLEEP** repeatedly until “SLEEP 00min.” appears on the display. (The **SLEEP** indicator goes off.)

Turning off the power also cancels the Sleep Timer.

Note:

If you use any of the **DSP** modes other than the **3D-PHONIC** modes and “**HEADPHONE**” with both front speakers activated, the speakers connected to the **FRONT SPEAKERS ②** terminals are deactivated.

CAUTION:

Be sure to turn down the volume before connecting or putting on headphones, as high volume can damage both the headphones and your hearing.

Note:

You cannot shut off the sound through the subwoofer using the **SPEAKERS 1** and **2** buttons.

Note:

When the TV is connected to the **TV SOUND/DBS** jacks on the rear:

The receiver will turn on soon again after the Sleep Timer shut off the receiver if the TV is kept turned on.

To prevent this from happening, make sure that you turn off the TV before the Sleep Timer turns off the receiver.

Attenuating the Input Signal

When the input level of the playing source through the analog terminals is too high, the sounds will be distorted. If this happens, you need to attenuate the input signal level to prevent the sound distortion.

On the front panel only:

Press and hold **SOUND SELECT/INPUT ATT** until “**INPUT ATT ON**” appears on the display.

The ATT indicator also lights up on the display.

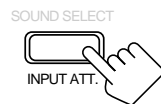

Each time you press and hold the button, the input attenuator mode turns on (“**INPUT ATT ON**”) and off (“**INPUT NORMAL**”).

You can set input attenuator mode separately for each source.

Adjusting the Subwoofer Output Level

You can adjust the subwoofer output level if you have selected “**YES**” for the “**SUBWOOFER**” (see page 18).

Once it has been adjusted, the receiver memorizes the adjustment.

On the front panel:

1. Press **BALANCE/SURROUND ADJUST** repeatedly until “**SUBWFR LEVEL**” appears on the display.

The display changes to show the current setting.



2. Turn **MULTI JOG** to adjust the subwoofer output level (–10 dB to +10 dB), while the indication of the previous step is still on the display.

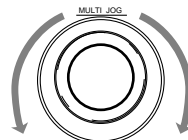

From the remote control:

1. Press **SOUND**.
10 keys are activated for sound adjustments.
2. Press **SUBWOOFER +/-** to adjust the subwoofer output level (–10 dB to +10 dB).

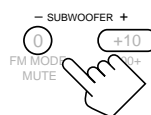
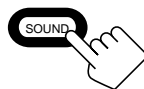

Notes:

- This function is available only for the sources connected using the analog terminals.
- This function takes effect only when the DSP mode is in use.

Recording a Source

You can record any source playing through the receiver to the cassette deck or the MD recorder connected to the TAPE/MD jacks and the VCRs connected to the VCR1 and VCR2 jacks at the same time.

While recording, you can listen to the selected sound source at whatever sound level you like, without affecting the sound levels of the recording.

Note:

The output volume level and SEA modes cannot affect the recording.

IMPORTANT:

When recording the digital source, turn off the DSP mode.

Basic Settings

Some of the following settings are required after connecting and positioning your speakers in your listening room, while others will make operations easier.

IMPORTANT:

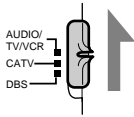

When using the Remote Control, check to see if its remote control mode selector is set to the correct position:
To operate this receiver, set it to "AUDIO/TV/VCR" (except when selecting the DBS tuner as the source).

Changing the Source Name

If you have connected an MD recorder to the TAPE/MD jacks or the DBS tuner to the TV SOUND/DBS jacks on the rear panel, change the source name shown on the display when you select the MD recorder or DBS tuner as the source.

On the front panel only:

1. When changing the source name from "TAPE" to "MD":
 - Turn SOURCE SELECTOR until "TAPE" appears.When changing the source name from "TV SOUND" to "DBS":
 - Turn SOURCE SELECTOR until "TV SOUND" appears.
2. Press and hold SOURCE NAME until "ASSGN. MD" or "ASSGN. DBS" appears on the display.

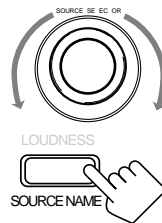

To change the source names to "TAPE" or "TV SOUND," repeat the same procedure above (in step 1, select "MD" or "DBS" then press and hold SOURCE NAME).

Selecting the Input Mode

When you have connected some components such as CD player, MD recorder, DVD player and the DBS tuner using digital terminals (see page 11), you need to change the input mode for these components to the digital input.

On the front panel:

1. Turn SOURCE SELECTOR until the source (CD, MD, DBS, or DVD) for which you want to change the input mode from analog input to digital input.
2. Press DIGITAL INPUT to change the input mode. Each time you press the button, the input mode alternates between the digital input and analog input.

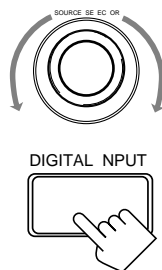

From the remote control:

1. Press the source selecting button (CD, TAPE/MD, TV/DBS, or DVD) for which you want to change the input mode from analog input to digital input.
2. Press DIGITAL/ANALOG INPUT to change the input mode. Each time you press the button, the input mode alternates between the digital input and analog input.

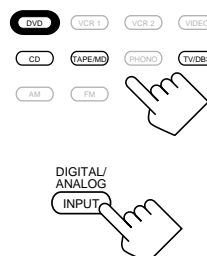

Note:

Without changing the source name, you can still use the connected components. However, there may be some inconvenience.

- "TAPE" or "TV SOUND" will appear on the display when you select the MD recorder or DBS tuner.
- You cannot use the digital input (see below) for the MD recorder and the DBS tuner.
- You cannot use the COMPU LINK remote control system (see page 48) to operate the MD recorder.

Note:

Once you have set the digital input for these components, it is always used every time you select these components as the source.

Adjusting the Front Speaker Output Balance

If the sounds you hear from the front right and left speakers are unequal, you can adjust the speaker output balance.

On the front panel *only*:

1. Press **BALANCE/SURROUND ADJUST** repeatedly until **“L/R BALANCE”** appears on the display.

The display changes to show the current setting.



2. Turn **MULTI JOG** to adjust the balance, while the indication of the previous step is still on the display.

- Turning it clockwise decreases the left channel output.
- Turning it counterclockwise decreases the right channel output.

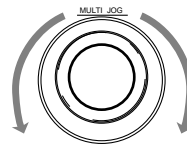

Setting the Subwoofer Information

Register whether or not you have connected a subwoofer.

On the front panel *only*:

1. Press **SETTING** repeatedly until **“SUBWOOFER”** appears on the display.

The display changes to show the current setting.



2. Turn **MULTI JOG** to register whether you have connected a subwoofer or not, while the indication of the previous step is still on the display.

As you turn it, the subwoofer setting alternates between **“YES”** and **“NO.”**

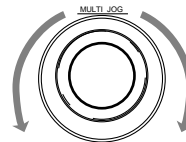

YES	Select this when you use a subwoofer.
NO	Select this when you do not use a subwoofer.

Listening at Low Volume (Loudness)

Human ears are not sensitive to bass at low volume. To compensate for this, the loudness function automatically boosts the bass level as you lower the volume.

On the front panel *only*:

Press **LOUDNESS/SOURCE NAME** briefly to select the loudness function.

Each time you press the button, the loudness function turns on (**“LOUDNESS ON”**) and off (**“LOUDNESS OFF”**).

- Select **“LOUDNESS ON”** to activate the loudness function. The **LOUDNESS** indicator lights up on the display.
- Select **“LOUDNESS OFF”** to cancel it. The indicator goes off.



Note:

The loudness function affects the front speaker sounds only.

Basic Settings

Digital Input (DIGITAL IN) Terminal Setting

When you use the digital input terminals, you have to register what components are connected to which terminals (DIGITAL IN 1/2/3).

On the front panel only:

1. Press **SETTING** repeatedly until “**DIGITAL IN**” appears on the display.

The display changes to show the current setting.

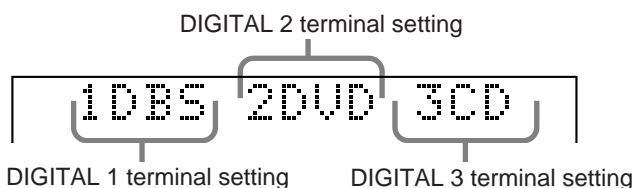

2. Turn **MULTI JOG** to select the appropriate digital terminal setting, while the indication of the previous step is still on the display.

As you turn it, the display changes to show the following:

- ⇨ 1 DBS 2 DVD 3 CD ⇨ 1 MD 2 DVD 3 CD ⇨ 1 MD 2 DBS 3 CD
- ⇨ 1 MD 2 DBS 3 DVD ⇨ 1 CD 2 DVD 3 MD ⇨ 1 CD 2 DBS 3 MD
- ⇨ 1 CD 2 DBS 3 DVD ⇨ 1 DVD 2 CD 3 MD ⇨ 1 DVD 2 DBS 3 MD
- ⇨ 1 DVD 2 DBS 3 CD ⇨ 1 DBS 2 CD 3 MD ⇨ DBS 2 DVD 3 MD
- ⇨ (back to the beginning)

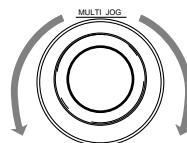

Setting the Speakers for the DSP Modes

To obtain the best possible surround sound of the DSP modes, you have to register the information about the speakers arrangement after all connections are completed.

Front, Center, and Rear Speaker Setting

Register the sizes of the other speakers.

On the front panel only:

1. Press **SETTING** repeatedly until “**FRONT SPK**” (Front Speaker), “**CENTER SPK**” (Center Speaker) or “**REAR SPK**” (Rear Speaker) appears on the display.

The display changes to show the current setting.

2. Turn **MULTI JOG** to select the appropriate item about your front, center and rear speakers, while the indication of the previous step is still on the display.

As you turn it, the display changes to show the following:

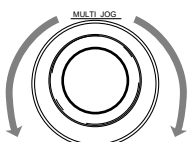
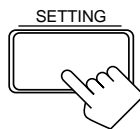
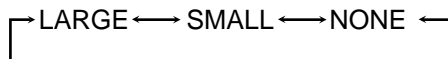

LARGE	Select this when the speaker size is relatively large.
SMALL	Select this when the speaker size is relatively small.
NONE	Select this when you have not connected a speaker. (Not selectable for the front speakers)

Note:

When shipped from the factory, the DIGITAL IN terminals can be used as the digital input for the following components.

- DIGITAL 1 (coaxial): For DBS tuner
- DIGITAL 2 (optical): For DVD player
- DIGITAL 3 (optical): For CD player

Note:

When you change your speakers, you need to register the information about the speakers again.

Notes:

- If the size of the cone speaker unit built in your speaker is greater than 4 3/4 inches (12 cm), select “LARGE,” and if it is smaller than 4 3/4 inches (12 cm), select “SMALL.”
- If you have selected “NO” for the subwoofer setting, you can only select “LARGE” for the front speaker setting.

Center Delay Time Setting

Register the delay time of the sound from the center speaker, comparing that of the sound from the front speakers.

If the distance from your listening point to the center speaker is equal to that to the front speakers, select 0 msec. As the distance to the center speaker becomes shorter, increase the delay time.

On the front panel only:

1. Press **SETTING** repeatedly until “**CENTER DELAY**” appears on the display.
The display changes to show the current setting.
2. Turn **MULTI JOG** to select the delay time of the center speaker output, while the indication of the previous step is still on the display.
 - Turn it clockwise to increase the delay time from 0 msec (“C. DELAY 0ms”) to 5 msec (“C. DELAY 5ms”).
 - Turn it counterclockwise to decrease the delay time from 5 msec (“C. DELAY 5ms”) to 0 msec (“C. DELAY 0ms”).

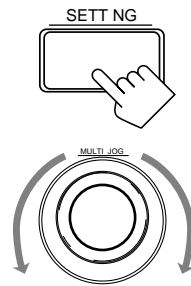

Note:

1 msec increase (or decrease) in delay time corresponds to 11 ¹³/₁₆ inches (30 cm) decrease (or increase) in distance.

Rear Delay Time Setting

Register the delay time of the sound from the rear speakers, comparing that of the sound from the front speakers.

If the distance from your listening point to the rear speakers is equal to that to the front speakers, select 0 msec. As the distance to the rear speakers becomes shorter, increase the delay time.

On the front panel only:

1. Press **SETTING** repeatedly until “**REAR DELAY**” appears on the display.
The display changes to show the current setting.
2. Turn **MULTI JOG** to select the delay time of the rear speaker output, while the indication of the previous step is still on the display.
 - Turn it clockwise to increase the delay time from 0 msec (“R. DELAY 0ms”) to 15 msec (“R. DELAY 15ms”).
 - Turn it counterclockwise to decrease the delay time from 15 msec (“R. DELAY 15ms”) to 0 msec (“R. DELAY 0ms”).

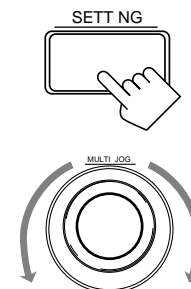

Notes:

- 1 msec increase (or decrease) in delay time corresponds to 11 ¹³/₁₆ inches (30 cm) decrease (or increase) in distance.
- It is recommended that the rear delay time for Dolby Digital be set to 5 msec.

Crossover Frequency Setting

Small speaker cannot reproduce the bass sound very well. So, if you have used a small speaker any for the front, center, or rear channels, this receiver automatically reallocate the bass elements, originally assigned to the channel for which you have connected the small speaker, to another channel (for which you have connected the large speaker).

To use this function properly, you need to set this crossover frequency level according to the size of the small speaker connected.

On the front panel only:

1. Press **SETTING** repeatedly until “**CROSSOVER FRQ**” (Crossover Frequency) appears on the display.
The display changes to show the current setting.

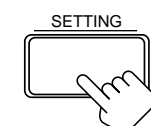

Note:

This function takes effect only when playing back a sources using the Dolby Digital. However, if you have selected “**LARGE**” for all speakers (see page 19), this function will not take effect.

Basic Settings

- Turn **MULTI JOG** to select the crossover frequency level according to the size of the small speaker connected, while the indication of the previous step is still on the display.

As you turn it, the display changes to show the following:

→ CROSS: 80Hz ↔ CROSS:100Hz ↔ CROSS:120Hz ←

CROSS: 80Hz	Select this when the cone speaker unit built in the speaker is about 4 ³ / ₄ inches (12 cm).
CROSS:100Hz	Select this when the cone speaker unit built in the speaker is about 3 ¹⁵ / ₁₆ inches (10 cm).
CROSS:120Hz	Select this when the cone speaker unit built in the speaker is about 3 ³ / ₁₆ inches (8 cm).

Low Frequency Effect Attenuator Setting

If the bass sound is distorted while playing back a source using Dolby Digital, follow the procedure below.

On the front panel only:

- Press **SETTING** repeatedly until “**LFE ATT**” (Low Frequency Effect Attenuator) appears on the display.
The display changes to show the current setting.
- Turn **MULTI JOG** to select the low frequency effect attenuator level, while the indication of the previous step is still on the display.

As you turn it, the display changes to show the following:

LFE ATT: 0dB ↔ LFE ATT:10dB

LFE ATT: 0dB:	Normally select this.
LFE ATT:10dB:	Select this when the bass sound is distorted.

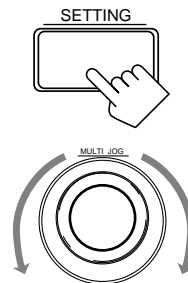

Dynamic Range Compression Setting

You can compress the dynamic range (difference between maximum sound and minimum sound) of the reproduced sound. This is useful when enjoying surround sound at night.

On the front panel only:

- Press **SETTING** repeatedly until “**D. RANGE COMP.**” (Dynamic Range Compression) appears on the display.
The display changes to show the current setting.
- Turn **MULTI JOG** to select the appropriate item about the compression level, while the indication of the previous step is still on the display.

As you turn it, the display changes to show the following:

→ COMP.: OFF ↔ COMP.: MID ↔ COMP.: MAX ←

COMP.: OFF	Select this when you want to enjoy surround with its full dynamic range. (No effect applied.)
COMP.: MID	Select this when you want to reduce the dynamic range a little. (Factory setting).
COMP.: MAX	Select this when you want to apply the compression effect fully. (Useful at night).

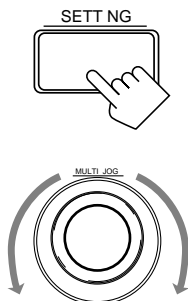

Note:

This function takes effect only when playing back a sources using the Dolby Digital.

Note:

This function takes effect only when playing back a sources using the Dolby Digital.

One Touch Operation

This receiver can memorize the optimum sound settings for each playing source.

About the One Touch Operation

JVC's One Touch Operation function is used to assign and store different sound settings for each different playing source. By using this function, you do not have to change the settings every time you change the source. The stored settings for the newly selected source are automatically recalled.

The following can be stored for each source:

- Volume level (see page 14)
- Input attenuator mode (see page 16)
- Subwoofer output level (see page 16)
- Input mode (see page 17)
- Balance (see page 18)
- Loudness (see page 18)
- SEA modes (see page 26)
- DSP modes
 - 3D-PHONIC mode settings (see page 29)
 - DAP mode settings (see page 32)
 - Surround mode settings (see page 34 and 37)

Using the One Touch Operation

On the front panel *only*:

To store the sound settings

1. **Press ONE TOUCH OPERATION.**
The ONE TOUCH OPERATION lamp lights up, then the previously memorized settings are recalled.
2. **Adjust the sound using the functions listed above.**
The newly adjusted settings are memorized.



To recall the sound settings

With the ONE TOUCH OPERATION lamp lit, the settings for the currently selected source is recalled when the source is selected.

To cancel the One Touch Operation function

Press ONE TOUCH OPERATION so that the lamp goes off. (Even though the One Touch Operation function is canceled, the recalled sound effects remain active.)



Note:

If the source is FM or AM, you can assign a different setting for each band.

Receiving Radio Broadcasts

You can browse through all the stations or use the preset function to go immediately to a particular station.

IMPORTANT:

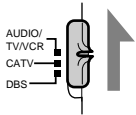

When using the Remote Control, check to see if its remote control mode selector is set to the correct position:

To operate this receiver, set it to “AUDIO/TV/VCR” (except when selecting the DBS tuner as the source).

Tuning in Stations Manually

On the front panel:

1. Press **FM/AM TUNING** to select the band.
Each time you press the button, the band alternates between FM and AM.
2. Turn **MULTI JOG** until you find the frequency you want.
 - Turning it clockwise increases the frequency.
 - Turning it counterclockwise decreases the frequency.

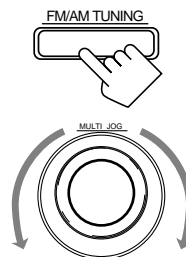

From the remote control:

1. Press **FM** or **AM** to select the band.
2. Press **TUNING DOWN** or **TUNING UP** repeatedly until you find the frequency you want.

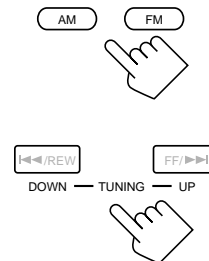

Using Preset Tuning

Once a station is assigned to a channel number, the station can be quickly tuned. You can preset up to 40 stations at random.

To store the preset stations

On the front panel only:

1. **Tune in the station you want to preset (see above).**
If you want to store the FM reception mode for this station, select the FM reception mode you want. See page 24 for details.
2. Press **TUNER/SEA MEMORY**.
“CH-” appears and the channel number position starts flashing on the display for about 5 seconds.
3. Turn **MULTI JOG** to select a channel number while the channel number position is flashing.
4. Press **TUNER/SEA MEMORY** again while the selected channel number is flashing on the display.
The selected channel number stops flashing.
The station is assigned to the selected channel number.

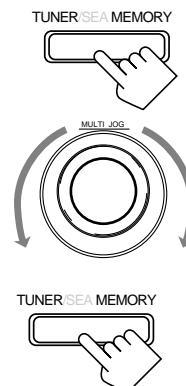

Notes:

- When you turn **MULTI JOG** quickly or hold the **TUNING UP** or **TUNING DOWN** in step 2, the frequency keeps changing until a station is tuned in.
- When a station of sufficient signal strength is tuned in, the **TUNED** indicator lights up on the display.
When an FM stereo program is received, the **STEREO** indicator also lights up.

Note:

You can use the 10 keys on the remote control to select the preset number. When using the 10 keys, be sure that they are activated for tuner, not for the CD and others. (See page 58.)

- Repeat steps 1 to 4 until you store all the stations you want.

To erase a stored preset station

Storing a new station on a used number erases the previously stored one.

To tune in a preset station

On the front panel:

- Press TUNER PRESET.
- Turn MULTI JOG to select a preset channel.

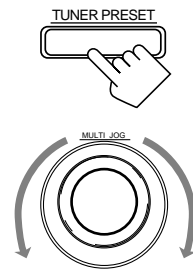

From the remote control:

- Press FM or AM.
- Press 10 keys to select a preset channel number.
 - For channel number 5, press 5.
 - For channel number 15, press +10 then 5.
 - For channel number 20, press +10 then 10.
 - For channel number 30, press +10, +10, then 10.



Note:

When you use the 10 keys on the remote control, be sure that they are activated for tuner, not for the CD and others. (See page 58.)

Selecting the FM Reception Mode

When an FM stereo broadcast is hard to receive or noisy, set the FM reception mode to “MONO.” (When shipped from the factory, this mode has been set to “AUTO.”) You can change the FM reception mode while receiving an FM broadcast.

Press FM MODE on the front panel or FM MODE/ MUTE on the remote control.

Each time you press the button, the FM reception mode alternates between “AUTO” and “MONO.”



Notes:

- You can store the FM reception mode for each preset station.
- When using the FM MODE/ MUTE button, be sure that the 10 keys are activated for tuner, not for the CD and others. (See page 58.)

AUTO:	When a program is broadcast in stereo, you will hear stereo sound; when in monaural, you will hear monaural sounds. This mode is also useful to suppress static noise between stations. The MUTE AUTO indicator lights up on the display.
MONO:	Reception will be improved although you will lose the stereo effect. In this mode, you will hear noise while tuning into the stations. The MUTE AUTO indicator goes off on the display.

Receiving Radio Broadcasts

Assigning Names to Preset Stations

You can assign a name of up to four characters to each preset station. When a preset station is tuned in, its assigned name will appear on the display.

On the front panel *only*:

1. Tune in a preset station.

See page 24 for details.

2. Press TUNER/SEA MEMORY.

The preset channel number starts flashing for about 5 seconds.



3. Press TUNER PRESET, while the preset channel number is flashing.

The first character position starts flashing.

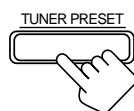
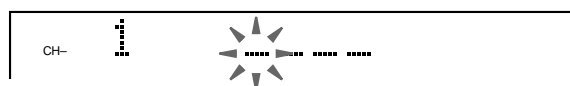

4. Turn MULTI JOG to select the first character, while the first character position is flashing..

You can use characters listed below.

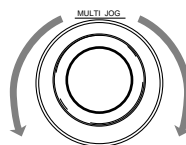
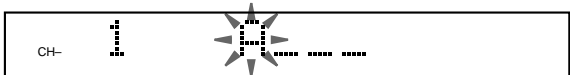

5. Press TUNER PRESET, while a character you want is flashing.

The next (or previous) character position starts flashing.

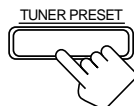
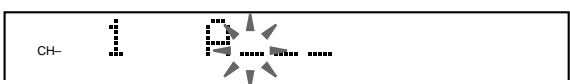

6. Repeat steps 4 and 5 to enter up to four characters.

7. Press TUNER/SEA MEMORY while the last selected character is flashing after you have assigned a name.



To erase the input characters

Insert spaces using the same procedure described above.

Available characters

Space

A B C D E F G H I J K L M N O

P Q R S T U V W X Y Z 0 1 2 3 4

5 6 7 8 9

Note:

If you turn MULTI JOG while the preset channel number is flashing, you can change the preset channel number.

Note on step 3 to 7:

You cannot select any entry after the indication on the display stops flashing. In this case, repeat the procedure from step 2 again.

Using the SEA Modes

The SEA (Sound Effect Amplifier) modes give you control of the way your music sounds.

IMPORTANT:

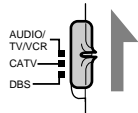

When using the Remote Control, check to see if its remote control mode selector is set to the correct position:
To operate this receiver, set it to “AUDIO/TV/VCR” (except when selecting the DBS tuner as the source).

Selecting Your Favorite SEA Mode

On the front panel:

1. Press SEA MODE.

The display changes to show the current setting.



2. Turn MULTI JOG until the mode you want appears on the display, while the indication of the previous step is still on the display.

As you turn it, the SEA mode changes as follows:

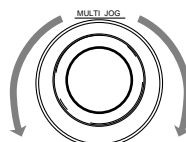
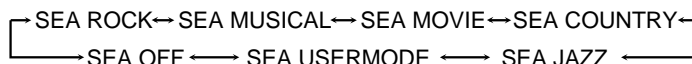

SEA ROCK:	Gives a heavy sound. Both high and low frequencies are boosted.
SEA MUSICAL:	Enhance the mid-frequency range, which the human voice is mostly made up of.
SEA MOVIE:	Adds breadth to sounds so you feel like you are in a movie theater.
SEA COUNTRY:	Enhances the high-frequency range so that instruments such as the violin and banjo are emphasized.
SEA JAZZ:	Gives a feeling of a live atmosphere. Good for acoustic music.
SEA USERMODE:	Your original SEA adjustment (see page 27).
SEA OFF:	No SEA mode is applied (see below).

To cancel the SEA mode

Turn MULTI JOG until “SEA OFF” appears in step 2 above.
 The SEA indicator goes off from the display.

From the remote control:

1. Press SOUND.

10 keys are activated for sound adjustments.

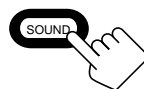

2. Press SEA MODE repeatedly until the SEA mode you want appears on the display.

Each time you press the button, the SEA mode changes as follows:

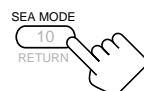
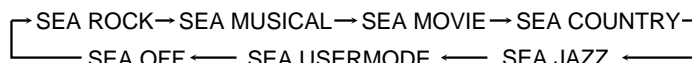

To cancel the SEA mode

Press SEA MODE until “SEA OFF” appears in step 2 above.
 The SEA indicator goes off from the display.

Notes:

- The SEA modes cannot be used for recording.
- When the SEA mode is turned on, the SEA indicator lights up on the display.
- When the SEA mode is used with the DAP mode (see page 32), sounds may be distorted. If this happens, turn off the DAP mode or decrease the effect level of the DAP mode.

Note:

When the SEA mode is turned on, the SEA indicator lights up on the display.

Using the SEA Modes

Creating Your Own SEA Mode

You can adjust and store your own SEA adjustment into memory (SEA USERMODE).

On the front panel *only*:

If you do not want to store your adjustment, but rather want to adjust the SEA temporarily, skip step 4 below.

1. Press SEA ADJUST repeatedly until the frequency range (100Hz, 1kHz or 10kHz) you want appears on the display.

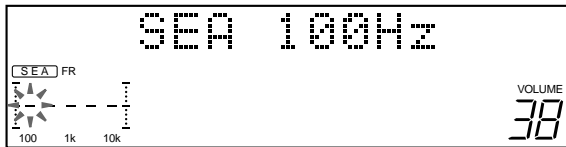

2. Turn MULTI JOG to adjust the SEA level of the selected frequency range, while the indication of the previous step is still on the display.

- Turning it clockwise increases the level.
- Turning it counterclockwise decreases the level.

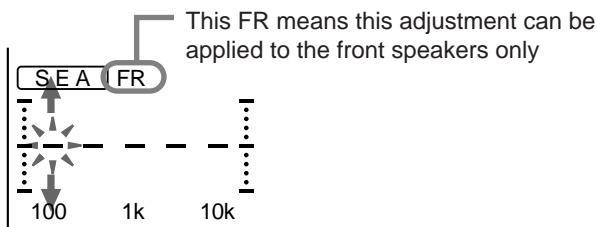
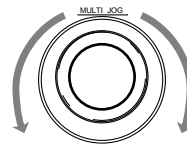

3. Repeat step 1 and 2 to adjust other frequency ranges if necessary.

4. Press TUNER/SEA MEMORY, while the indication of the previous step is still on the display.

Your adjustment is stored into the SEA USERMODE.



To recall your own SEA adjustment

See page 26.

To erase a stored adjustment

Storing a new adjustment into SEA USERMODE erases the previously stored one.

Using the DSP Modes

The built-in Surround Processor provides three types of the DSP (Digital Signal Processor) mode — 3D-PHONIC mode, DAP (Digital Acoustic Processor) mode and Surround mode (Dolby Digital, Dolby Pro Logic and JVC's Theater Surround.)

On the 3D-PHONIC mode

The 3D-PHONIC mode gives you such a nearly surround effect as it is reproduced through the Dolby Surround decoder, which is widely used to reproduce sounds with a feeling of movement like those experienced in movie theaters. The 3D-PHONIC mode is the result of research on sound localization technology carried out at JVC for many years and makes it possible to reproduce the surround sound **with only two front speakers**.

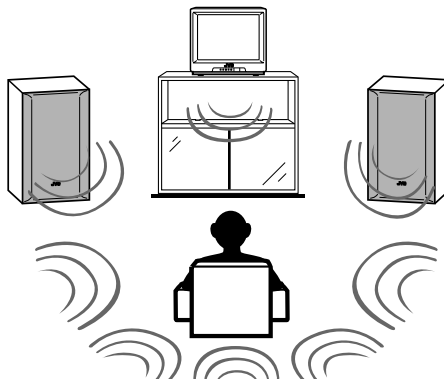

On the DAP mode

The sound heard in a concert hall or club consists of direct sound and indirect sound — early reflections and reflections from behind. Direct sounds reach the listener directly without any reflection. On the other hand, indirect sounds are delayed by the distances of the ceiling and walls. These direct sounds and indirect sounds are the most important elements of the acoustic surround effects. The DAP mode can create these important elements, and gives you a real “being there” feeling.

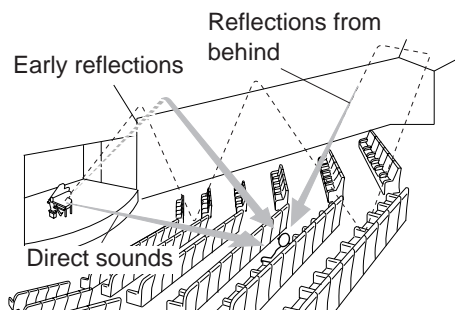

On Surround mode

With this receiver, you can use two types of the surround mode.

Dolby Surround (Dolby Digital and Dolby Pro Logic)

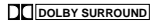
Used to watch the soundtracks of software encoded with Dolby Digital (bearing the mark ) or with Dolby Surround (bearing the mark ) . Dolby Digital and Dolby Pro Logic can be selected automatically according to software played back.

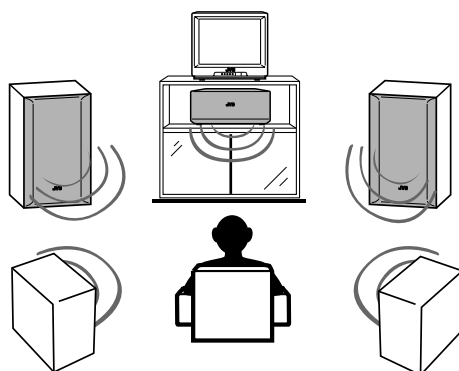

JVC's Theater Surround

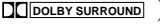
In order to reproduce a more realistic sound field in your listening room while playing soundtracks of software encoded with Dolby Digital (bearing the mark ) or with Dolby Surround (bearing the mark ) , Theater Surround has been designed to create a real “being there” feeling.

Notes:

- The DSP modes have no effect on monaural sources.
- You can not use the two types of the DSP modes at the same time.

IMPORTANT:

When recording the digital source, turn off the DSP mode.

Note:

To enjoy the software encoded with Dolby Digital, you must connect the source component using the digital terminal on the rear of this receiver.

Manufactured under license from Dolby Laboratories. “Dolby,” “Pro Logic,” and the double-D symbol are trademarks of Dolby Laboratories. Confidential Unpublished Works. ©1992–1997 Dolby Laboratories, Inc. All rights reserved.

Using the DSP Modes

IMPORTANT:

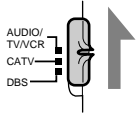

When using the Remote Control, check to see if its remote control mode selector is set to the correct position:
To operate this receiver, set it to “AUDIO/TV/VCR” (except when selecting the DBS tuner as the source).

Using the 3D-PHONIC Modes

When using the 3D-PHONIC modes, you need only two front speakers to reproduce the soundtracks of software encoded with Dolby Digital (bearing the mark) or with Dolby Surround (bearing the mark).

On the front panel:

1. Select and play the source encoded with Dolby Digital (bearing the mark) or with Dolby Surround (bearing the mark).
 • When you play back the source encoded with Dolby Digital and select the digital input for that source, the DIGITAL indicator lights up on the display.

2. Press DSP MODE.

The current DSP mode appears on the display.

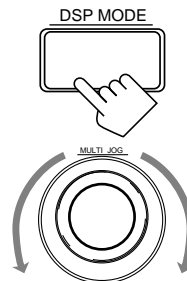

3. Turn MULTI JOG until the mode — 3D ACTION (or 3D DIGITAL), 3D DRAMA, or 3D THEATER — you want appears on the display, while the indication of the previous step is still on the display.

As you turn it, the DSP modes change as follows (the 3D-PHONIC and DSP indicators also light up on the display):

When the digital input is selected to play the source encoded with Dolby Digital:

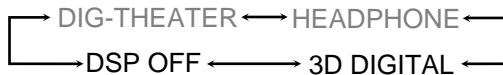

For other sources:

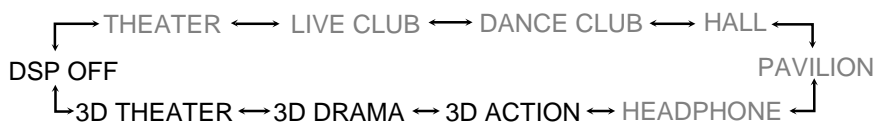

3D ACTION:	Best for action and war movies — where the action is fast and explosive.
3D DRAMA:	Best for dramas and romantic movies — where the action is slow and soft.
3D THEATER:	Reproduces the sound field of a theater.
3D DIGITAL:	Reproduces multi-sound source encoded with Dolby Digital.
DSP OFF:	No DSP mode is applied.

For the other modes, see pages 32 and 37.

If you need to make any adjustment, go to the following steps.

Notes:

- To enjoy the software encoded with Dolby Digital, you must connect the source component using the digital terminal on the rear of this receiver.
- The 3D-PHONIC mode is not used with the other DSP modes such as the DAP mode and the Surround mode. When the 3D-PHONIC mode is turned on, the other DSP mode, if used, will be turned off.

Notes on the indications:

- The indicator of the selected DSP mode also lights up on the display while selecting.
- The PRO LOGIC indicator lights up when the Dolby Pro Logic decoder built in this receiver is activated.
- The Dolby Pro Logic decoder is used not only for the analog sources but also for the sources encoded with Dolby Digital in the following cases:
 - When only front channel signals are encoded.
 - When front channel and monaural rear channel signals are encoded.
 While the Dolby Pro Logic is activated for this type of Dolby Digital source, the DIGITAL indicator goes off.

4. Press **BALANCE/SURROUND ADJUST** repeatedly until **“DSP EFFECT”** appears on the display.

The display changes to show the current setting.

BALANCE/SURROUND
ADJUST



5. Turn **MULTI JOG** to select the effect level, while the indication of the previous step is still on the display.

As you turn it, the effect level changes as follows:

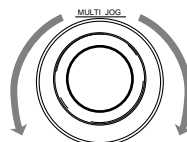
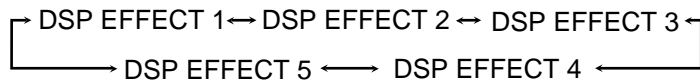

As the number increases, the selected 3D-PHONIC mode becomes stronger.

To cancel the 3D-PHONIC mode

Turn **MULTI JOG** until **“DSP OFF”** appears in step 3.

The 3D-PHONIC and DSP indicators go off from the display.

Note:

Once you have adjusted the 3D-PHONIC modes, it is memorized for each 3D-PHONIC mode.

Using the DSP Modes

From the remote control:

1. Select and play the source encoded with Dolby Digital (bearing the mark ) or with Dolby Surround (bearing the mark ).

- When you play back the source encoded with Dolby Digital and select the digital input for that source, the  DIGITAL indicator lights up on the display.

2. Press SURROUND MODE repeatedly until the mode — 3D ACTION (or 3D DIGITAL), 3D DRAMA, or 3D THEATER — you want appears on the display.

Each time you press the button, the DSP modes change as follows (the 3D-PHONIC and DSP indicators also light up on the display):

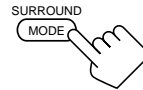

When the digital input is selected to play the source encoded with Dolby Digital:

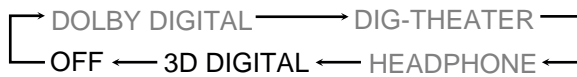

For other sources:

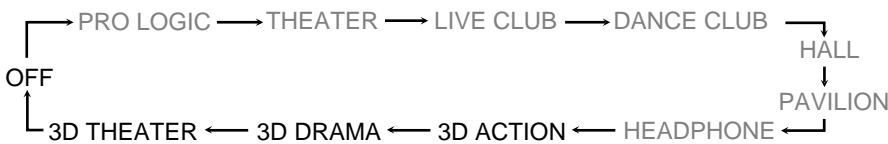

3. Press SOUND.

10 keys are activated for sound adjustments.

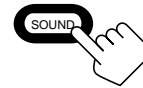

4. Press EFFECT to select the effect level.

Each time you press the button, the effect level changes as follows:

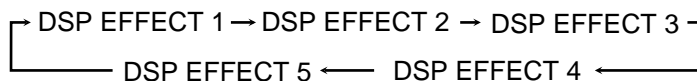

As the number increases, the selected 3D-PHONIC mode becomes stronger.

To cancel the 3D-PHONIC mode

Press SURROUND MODE repeatedly until “OFF” appears. The 3D-PHONIC and DSP indicators go off from the display.

Note:

The 3D-PHONIC mode is not used with the other DSP modes such as the DAP mode and the Surround mode. When the 3D-PHONIC mode is turned on, the other DSP mode, if used, will be turned off.

Notes on the indications:

- The indicator of the selected DSP mode also lights up on the display while selecting.
- The PRO LOGIC indicator lights up when the Dolby Pro Logic decoder built in this receiver is activated.
- The Dolby Pro Logic decoder is used not only for the analog sources but also for the sources encoded with Dolby Digital in the following cases:
 - When only front channel signals are encoded.
 - When front channel and monaural rear channel signals are encoded.
 While the Dolby Pro Logic is activated for this type of Dolby Digital source, the  DIGITAL indicator goes off.

Note:

Once you have adjusted the 3D-PHONIC modes, it is memorized for each 3D-PHONIC mode.

Using the DAP Modes

You can use five DAP modes — “Live Club, Dance Club, Hall, Pavilion, and Headphones” for any source.

Among the DAP modes, “Headphones” is very special. It can create the same stereo sound as you listen through the speakers off air while listening to a source using headphones. So, you can feel as if you were not using the headphones and listening to music in a room.

If the digital input is selected to play the source encoded with Dolby Digital, you can only select “Headphones.”

On the front panel:

1. Press DSP MODE.

The current DSP mode appears on the display.

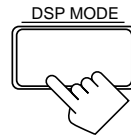

2. Turn MULTI JOG until the mode (LIVE CLUB, DANCE CLUB, HALL, PAVILION, or HEADPHONE) you want appears on the display, while the indication of the previous step is still on the display.

The DSP indicator also lights up on the display.

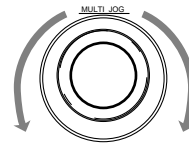

As you turn it, the DSP modes change as follows:

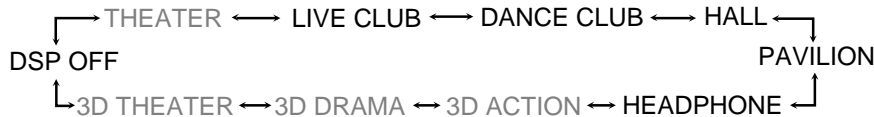

When the digital input is selected to play the source encoded with Dolby Digital:

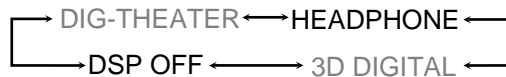

LIVE CLUB:	Gives the feeling of a live music club with a low ceiling.
DANCE CLUB:	Gives a throbbing bass beat.
HALL:	Gives clear vocal and the feeling of a concert hall.
PAVILION:	Gives the spacious feeling of a pavilion with a high ceiling.
HEADPHONE:	Gives a spacious stereo effect when listening with headphones.
DSP OFF:	No DSP mode is applied.

For the other modes, see pages 29 and 37.

If you need to make any adjustment, go to the following steps.

3. Adjust the speaker output levels as follows.

- 1) Press **BALANCE/SURROUND ADJUST** repeatedly until one of the indications appears on the display.
 - “REAR L LEVEL”: To adjust the left speaker level.
 - “REAR R LEVEL”: To adjust the right speaker level.
- 2) Turn **MULTI JOG** to adjust the selected speaker output level (from -10 dB to +10 dB), while the indication of the previous step is still on the display.
- 3) Repeat 1) and 2) to adjust the other speaker output levels.

BALANCE SURROUND
ADJUST

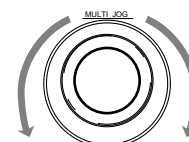
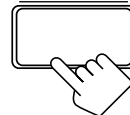

Continued to the next page.

Notes:

- The DAP mode is not used with the other DSP modes such as the 3D-PHONIC mode and the Surround mode. When the DAP mode is turned on, the other DSP mode, if used, will be turned off.
- When the DAP mode is used with the SEA mode (see page 26), sounds may be distorted. If this happens, turn off the SEA mode.

Note:

The indicator of the selected DSP mode also lights up on the display while selecting.

Note:

When you select “HEADPHONE,” you cannot go to the following steps. No adjustments can be made for HEADPHONE.”

Note:

You cannot adjust the rear speaker levels when “REAR SPK” is set to “NONE” (see page 19).

Using the DSP Modes

4. Adjust the effect level.

- 1) Press **BALANCE/SURROUND ADJUST** repeatedly until “**DSP EFFECT**” appears on the display.
- 2) Turn **MULTI JOG** to select the effect level, while the indication of the previous step is still on the display.

As you turn it, the effect level changes as follows:

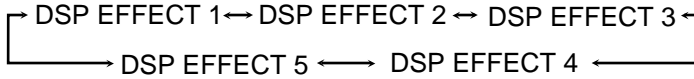

As the number increases, the selected DAP mode becomes stronger.

BALANCE/SURROUND
ADJUST

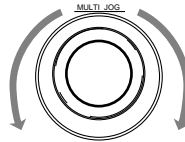
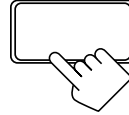

Note:

Once you have adjusted the DAP modes, the adjustment is memorized for each DAP mode.

To cancel the DAP mode

Turn **MULTI JOG** until “**DSP OFF**” appears in step 2. The DSP indicator goes off from the display.

From the remote control:

1. Press **SURROUND MODE** repeatedly until the mode you want appears on the display.

The DSP indicator also lights up on the display.

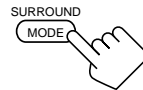

Each time you press the button, the DSP modes change as follows (the indicator of the selected DSP mode also lights up on the display):

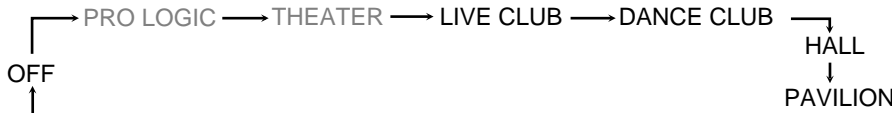

When the digital input is selected to play the source encoded with Dolby Digital:



Note:

The DAP mode is not used with the other DSP modes such as the 3D-PHONIC mode and the Surround mode. When the DAP mode is turned on, the other DSP mode, if used, will be turned off.

Note:

When you select “**HEADPHONE**,” you cannot go to the following steps. No adjustments can be made for “**HEADPHONE**.”

If you need to make any adjustment, go to the following steps.

2. Press **SOUND**.

10 keys are activated for sound adjustments.

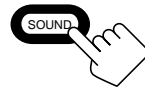

3. Adjust the speaker output levels as follows:

- To adjust the left rear speaker level, press **REAR•L +/-**.
- To adjust the right rear speaker level, press **REAR•R +/-**.

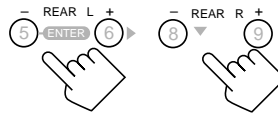

Note:

You cannot adjust the rear speaker levels when “**REAR SPK**” is set to “**NONE**” (see page 19).

4. Press **EFFECT** to select the effect level.

Each time you press the button, the effect level changes as follows:

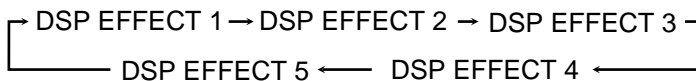

As the number increases, the selected DAP mode becomes stronger.



Note:

Once you have adjusted the DAP modes, the adjustment is memorized for each DAP mode.

To cancel the DAP mode

Press **SURROUND MODE** repeatedly until “**OFF**” appears. The DSP indicator goes off from the display.

Using the Dolby Digital and Dolby Pro Logic Modes

Once you have adjusted the Dolby Digital and Dolby Pro Logic modes, this receiver memorizes adjustment for each mode. To activate the Dolby Digital and Dolby Pro Logic modes, follow the procedure below.

From the remote control:

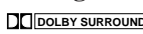
1. Select and play the source encoded with Dolby Digital (bearing the mark ) or with Dolby Surround (bearing the mark ).

- When you play back the source encoded with Dolby Digital and select the digital input for that source, the  DIGITAL indicator lights up on the display.

2. Press SURROUND MODE repeatedly until “PRO LOGIC” or “DOLBY DIGITAL” appears on the display.

Dolby Digital or Dolby Pro Logic is automatically selected according to the source being played back.

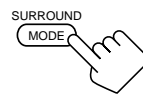

When Dolby Pro Logic is selected, the lamp on the DOLBY SURROUND button (on the front panel) lights red.

When Dolby Digital is selected, the lamp on the DOLBY SURROUND button (on the front panel) lights green.

Each time you press the button, the DSP modes change as follows:

When the digital input is selected to play the source encoded with Dolby Digital:



For other sources:

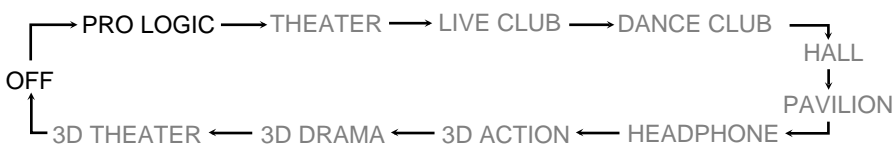

If you need to make any adjustment, go to the following steps.

3. Press SOUND.

10 keys are activated for sound adjustments.

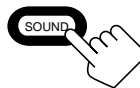

Continued to the next page.

Notes:

- To enjoy the software encoded with Dolby Digital, you must connect the source component using the digital terminal on the rear of this receiver.
- When the signals come into this receiver through the analog connection from the source component, “PRO LOGIC” is automatically selected.
- The Surround mode is not used with the other DSP modes such as the DAP mode and 3D-PHONIC mode. When the Surround mode is turned on, the other DSP mode, if used, will be turned off.

Notes on the indications:

- The PRO LOGIC indicator lights up when the Dolby Pro Logic decoder built in this receiver is activated.
 - The Dolby Pro Logic decoder is used not only for the analog sources but also for the sources encoded with Dolby Digital in the following cases:
 - When only front channel signals are encoded.
 - When front channel and monaural rear channel signals are encoded.
- While the Dolby Pro Logic is activated for this type of Dolby Digital source, the  DIGITAL indicator goes off.

Using the DSP Modes

4. Press TEST to start checking the speaker output balance.

“TEST TONE L” starts flashing on the display, and a test tone comes out of the speakers in the following order:

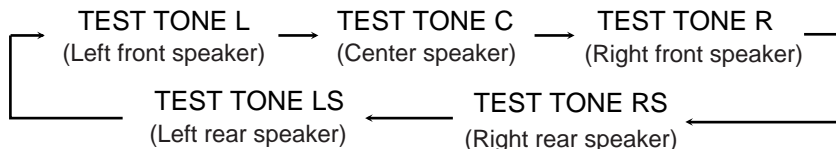

L **C** **R**

The speaker indicators also light on the display while the test tone comes out of the speakers.

LS **RS**

L: Lights when the test tone comes out of the left front speaker.
 C: Lights when the test tone comes out of the center speaker.
 R: Lights when the test tone comes out of the right front speaker.
 RS: Lights when the test tone comes out of the right rear speaker.
 LS: Lights when the test tone comes out of the left rear speaker.

IMPORTANT:

- Output the test tone while playing back an audio source. With the DVD digital input selected as the source, no test tone may come out while no signal is input to this receiver.
- Test tone comes out even while playing back a source encoded with Dolby Digital. In this case, the PRO LOGIC indicator lights up on the display.

5. Adjust the speaker output levels as follows:

- To adjust the center speaker level, press CNTR +/-.
- To adjust the left rear speaker level, press REAR•L +/-.
- To adjust the right rear speaker level, press REAR•R +/-.

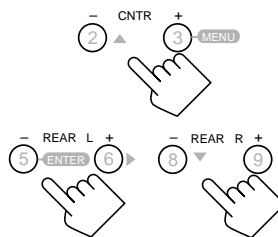

6. Press TEST again to stop the test tone.



7. Press CNTR TONE to select the center tone level you want.

The center tone adjustment affects the mid-frequency range, which the human voice is mostly made up of. Each time you press the button, the display changes to show the following:



Adjusted levels are also shown on the equalizer display.

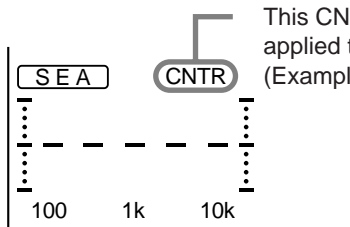

This CNTR means this adjustment can be applied to the center speaker only. (Example: When “FLAT” is selected.)

To make the dialogue clearer, select “SHARP1” (little) or “SHARP2” (much).

To make the dialogue softer, select “SOFT1” (little) or “SOFT2” (much).

When “FLAT” is selected, no adjustment is applied.

Notes:

- No test tone comes out of the center speakers when “CENTER SPK” is set to “NONE” (see page 19).
- No test tone comes out of the rear speakers when “REAR SPK” is set to “NONE” (see page 19).
- If the TV is turned on and the proper video input is selected on the TV, the test tone screen will appear on the TV.

Notes:

- You can adjust the speaker output levels and center tone without outputting the test tone.
- You cannot adjust the center speaker output level when “CENTER SPK” is set to “NONE” (see page 19).
- You cannot adjust the rear speaker levels when “REAR SPK” is set to “NONE” (see page 19).

Note:

The center tone cannot be adjusted when “CENTER SPK” is set to “NONE” (see page 19).

To cancel the Surround mode

Press SURROUND MODE repeatedly until “OFF” appears.

On the front panel:

You can also use the buttons on the front panel to adjust the Dolby Digital and Dolby Pro Logic modes. However, no test tone is available when using the buttons on the front panel. So, make adjustments while listening to the sound of the source played back.

1. Select and play the source encoded with Dolby Digital (bearing the mark

) or with Dolby Surround (bearing the mark ).

- When you play back the source encoded with Dolby Digital and select the digital input for that source, the  DIGITAL indicator lights up on the display.

2. Press DOLBY SURROUND so that the lamp on the button lights up.

“SURROUND ON” appears on the display.

Dolby Digital or Dolby Pro Logic is automatically selected according to the source being played back.

DOLBY SURROUND

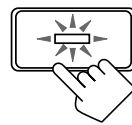

When Dolby Pro Logic is selected, the lamp on the DOLBY SURROUND button lights red.

When Dolby Digital is selected, the lamp on the DOLBY SURROUND button lights green.

If you need to make any adjustment, go to the following steps.

3. Adjust the speaker output levels as follows.

1) Press BALANCE/SURROUND ADJUST repeatedly until one of the indications appears on the display.

“CENTER LEVEL”: To adjust the center speaker level.

“REAR L LEVEL”: To adjust the left speaker level.

“REAR R LEVEL”: To adjust the right speaker level.

2) Turn MULTI JOG to adjust the selected speaker output level (from -10 dB to +10 dB), while the indicator of the previous step is still on the display.

3) Repeat 1) and 2) to adjust the other speaker output levels.

BALANCE/SURROUND
ADJUST

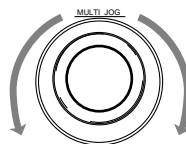
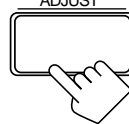

BALANCE/SURROUND
ADJUST

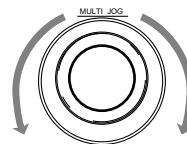
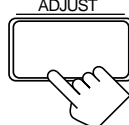

4. Press BALANCE/SURROUND ADJUST repeatedly until “CENTER TONE” appears on the display.

The display changes to show the current setting.

5. Turn MULTI JOG to select the center tone level you want, while the indication of the previous step is still on the display.

The center tone adjustment affects the mid-frequency range, which the human voice is mostly made up of.

As you turn it, the display changes to show the following:

SOFT2 ↔ SOFT1 ↔ FLAT ↔ SHARP1 ↔ SHARP2

To make the dialogue clearer, select “SHARP1” (little) or “SHARP2” (much).

To make the dialogue softer, select “SOFT1” (little) or “SOFT2” (much).

When “FLAT” is selected, no adjustment is applied.

To cancel the surround mode

Press DOLBY SURROUND again so that “SURROUND OFF” appears.

Notes:

- To enjoy the software encoded with Dolby Digital, you must connect the source component using the digital terminal on the rear of this receiver.
- When the signals come into this receiver through the analog connection from the source component, “PRO LOGIC” is automatically selected.
- The Surround mode is not used with the other DSP modes such as the DAP mode and 3D-PHONIC mode. When the Surround mode is turned on, the other DSP mode, if used, will be turned off.

Notes on the indications:

- The PRO LOGIC indicator lights up when the Dolby Pro Logic decoder built in this receiver is activated.
- The Dolby Pro Logic decoder is used not only for the analog sources but also for the sources encoded with Dolby Digital in the following cases:
 - When only front channel signals are encoded.
 - When front channel and monaural rear channel signals are encoded.While the Dolby Pro Logic is activated for this type of Dolby Digital source, the  DIGITAL indicator goes off.

Notes:

- You cannot adjust the center speaker level when “CENTER SPK” is set to “NONE” (see page 19).
- You cannot adjust the rear speaker levels when “REAR SPK” is set to “NONE” (see page 19).

Using the DSP Modes

Using the Theater Surround Mode

Once you have adjusted the Theater Surround mode, this receiver memorizes the adjustment. To activate the Theater Surround mode, follow the procedure below.

From the remote control:

1. Select and play the source encoded with Dolby Digital (bearing the mark

) or with Dolby Surround (bearing the mark ).

- When you play back the source encoded with Dolby Digital and select the digital input for that source, the  DIGITAL indicator lights up on the display.

2. Press SURROUND MODE repeatedly until "THEATER" or "DIG-THEATER" appears on the display.

The DSP and THEATER indicators also light up on the display.

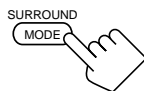

Each time you press the button, the DSP modes change as follows:

When the digital input is selected to play the source encoded with Dolby Digital:



For other sources:

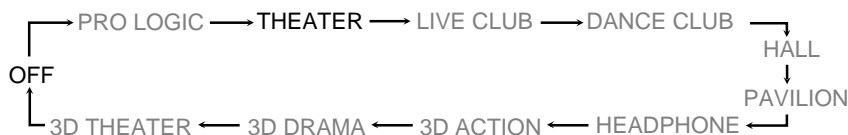

If you need to make any adjustment, go to the following steps.

3. Press SOUND.

10 keys are activated for sound adjustments.

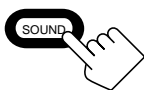

4. Press TEST to start checking the speaker output balance.

"TEST TONE L" starts flashing on the display, and a test tone comes out of the speakers in the following order:

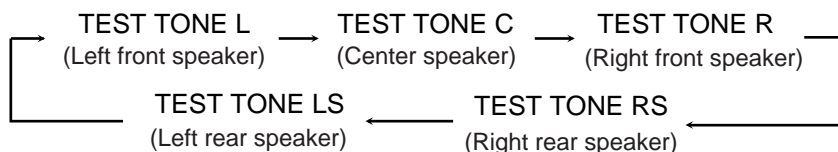

The speaker indicators also light on the display while the test tone comes out of the speakers.

 

- L: Lights when the test tone comes out of the left front speaker.
- C: Lights when the test tone comes out of the center speaker.
- R: Lights when the test tone comes out of the right front speaker.
- RS: Lights when the test tone comes out of the right rear speaker.
- LS: Lights when the test tone comes out of the left rear speaker.

Notes:

- To enjoy the software encoded with Dolby Digital, you must connect the source component using the digital terminal on the rear of this receiver.
- The Surround mode is not used with the other DSP modes such as the DAP mode and 3D-PHONIC mode. When the Surround mode is turned on, the other DSP mode, if used, will be turned off.

Notes on the indications:

- The PRO LOGIC indicator lights up when the Dolby Pro Logic decoder built in this receiver is activated.
- The Dolby Pro Logic decoder is used not only for the analog sources but also for the sources encoded with Dolby Digital in the following cases:
 - When only front channel signals are encoded.
 - When front channel and monaural rear channel signals are encoded.
 While the Dolby Pro Logic is activated for this type of Dolby Digital source, the  DIGITAL indicator goes off.

Notes:

- No test tone comes out of the center speakers when "CENTER SPK" is set to "NONE" (see page 19).
- No test tone comes out of the rear speakers when "REAR SPK" is set to "NONE" (see page 19).
- If the TV is turned on and the proper video input is selected on the TV, the test tone screen will appear on the TV.

IMPORTANT:

- Output the test tone while playing back an audio source. With the DVD digital input selected as the source, no test tone may come out while no signal is input to this receiver.
- Test tone comes out even while playing back a source encoded with Dolby Digital. In this case, the PRO LOGIC indicator lights up on the display.

5. Adjust the speaker output levels as follows:

- To adjust the center speaker level, press CNTR +/-.
- To adjust the left rear speaker level, press REAR•L +/-.
- To adjust the right rear speaker level, press REAR•R +/-.

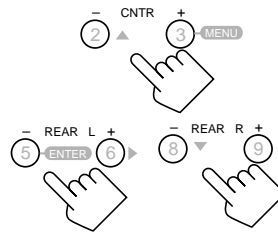

6. Press TEST again to stop the test tone.



7. Press CNTR TONE to select the center tone level you want.

The center tone adjustment affects the mid-frequency range, which the human voice is mostly made up of. Each time you press the button, the display changes to show the following:



Adjusted levels are also shown on the equalizer display.

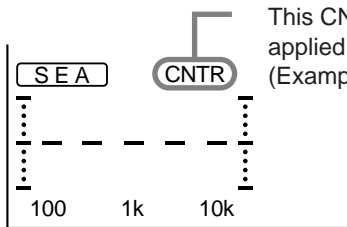

This CNTR means this adjustment can be applied to the center speaker only. (Example: When “FLAT” is selected.)

To make the dialogue clearer, select “SHARP1” (little) or “SHARP2” (much).
To make the dialogue softer, select “SOFT1” (little) or “SOFT2” (much).
 When “FLAT” is selected, no adjustment is applied.

8. Press EFFECT to select the effect level.

Each time you press the button, the effect level changes as follows:

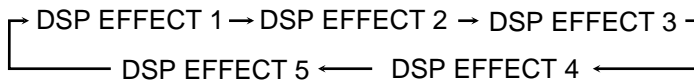

As the number increases, the surround effect becomes stronger.

To cancel the Theater Surround mode

Press SURROUND MODE repeatedly until “OFF” appears. The DSP and THEATER indicators goes off.

Notes:

- You can adjust the speaker output levels and center tone without outputting the test tone.
- You cannot adjust the center speaker level when “CENTER SPK” is set to “NONE” (see page 19).
- You cannot adjust the rear speaker levels when “REAR SPK” is set to “NONE” (see page 19).

Note:

The center tone cannot be adjusted when “CENTER SPK” is set to “NONE” (see page 19).

Note:

You cannot adjust the effect level when “REAR SPK” is set to “NONE” (see page 19).

Using the DSP Modes

On the front panel:

You can also use the buttons on the front panel to adjust the Theater Surround mode. However, no test tone is available when using the buttons on the front panel. So, make adjustments while listening to the sound of the source played back.

1. Select and play the source encoded with Dolby Digital (bearing the mark) or with Dolby Surround (bearing the mark).

- When you play back the source encoded with Dolby Digital and select the digital input for that source, the  DIGITAL indicator lights up on the display.

2. Press DSP MODE.

The current DSP mode appears on the display.

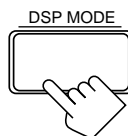

3. Turn MULTI JOG until "THEATER" or "DIG-THEATER" appears on the display, while the indication of the previous step is still on the display.

The DSP and THEATER indicators also light up on the display.

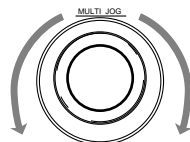

As you turn it, the DSP modes change as follows:

When the digital input is selected to play the source encoded with Dolby Digital:

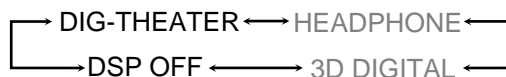

For other sources:

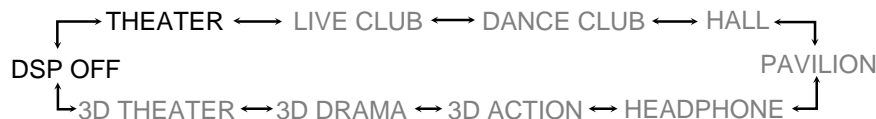

If you need to make any adjustment, go to the following steps.

4. Adjust the speaker output levels as follows.

- 1) Press BALANCE/SURROUND ADJUST repeatedly until one of the indications appears on the display.
 - “CENTER LEVEL”: To adjust the center speaker level.
 - “REAR L LEVEL”: To adjust the left speaker level.
 - “REAR R LEVEL”: To adjust the right speaker level.
- 2) Turn MULTI JOG to adjust the selected speaker output level (from -10 dB to +10 dB), while the indication of the previous step is still on the display.
- 3) Repeat 1) and 2) to adjust the other speaker output levels.

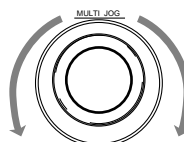

Notes:

- To enjoy the software encoded with Dolby Digital, you must connect the source component using the digital terminal on the rear of this receiver.
- The Surround mode is not used with the other DSP modes such as the DAP mode and 3D-PHONIC mode. When the Surround mode is turned on, the other DSP mode, if used, will be turned off.

Notes on the indications:

- The PRO LOGIC indicator lights up when the Dolby Pro Logic decoder built in this receiver is activated.
 - The Dolby Pro Logic decoder is used not only for the analog sources but also for the sources encoded with Dolby Digital in the following cases:
 - When only front channel signals are encoded.
 - When front channel and monaural rear channel signals are encoded.
- While the Dolby Pro Logic is activated for this type of Dolby Digital source, the  DIGITAL indicator goes off.

Notes:

- You cannot adjust the center speaker level when “CENTER SPK” is set to “NONE” (see page 19).
- You cannot adjust the rear speaker levels when “REAR SPK” is set to “NONE” (see page 19).

5. Press **BALANCE/SURROUND ADJUST** repeatedly until **“CENTER TONE”** appears on the display.

The display changes to show the current setting.



6. Turn **MULTI JOG** to select the center tone level you want, while the indication of the previous step is still on the display.

The center tone adjustment affects the mid-frequency range, which the human voice is mostly made up of. As you turn it, the display changes to show the following:

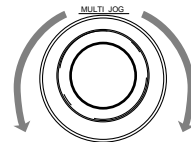

SOFT2 ↔ SOFT1 ↔ FLAT ↔ SHARP1 ↔ SHARP2

7. Press **BALANCE/SURROUND ADJUST** repeatedly until **“DSP EFFECT”** appears on the display.

The display changes to show the current setting.



8. Turn **MULTI JOG** to select the effect level, while the indication of the previous step is still on the display.

As you turn it, the effect level changes as follows:

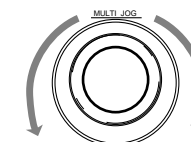

DSP EFFECT 1 ↔ DSP EFFECT 2 ↔ DSP EFFECT 3
 DSP EFFECT 5 ↔ DSP EFFECT 4

As the number increases, the surround effect becomes stronger.

To cancel the Theater Surround mode

Turn **MULTI JOG** until **“DSP OFF”** appears in step 3. The DSP and THEATER indicators goes off.

Note:

You cannot adjust the effect level when “REAR SPK” is set to “NONE” (see page 19).

Using the On-Screen Menus

You can use the menus on the TV screen to control the receiver.

To use this function, you need to connect the TV to the MONITOR OUT jack on the rear panel (see page 9), and set the TV's input mode to the proper position to which the receiver is connected.

Selecting the Source to Play (Also see page 13)

1. Press any button of ON SCREEN CONTROL Δ / ∇ / \triangleleft / \triangleright once.

The MAIN MENU appears on the TV.

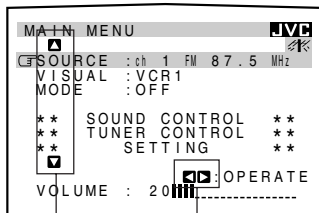

MAIN MENU

Shows the buttons you can use on the current menu.
In this case, use Δ / ∇ to move \square up and down, and \triangleleft / \triangleright to select, adjust or set the item.

2. Press ON SCREEN CONTROL Δ / ∇ to move \square to "SOURCE."

3. Press ON SCREEN CONTROL \triangleleft / \triangleright to select the source.

4. When you finish, press EXIT.

The menu disappears from the TV.

Selecting the Different Sources for Picture and Sound

You can view the pictures played back on a video component while listening to any source.

1. Press any button of ON SCREEN CONTROL Δ / ∇ / \triangleleft / \triangleright once.

The MAIN MENU appears on the TV.

2. Press ON SCREEN CONTROL Δ / ∇ to move \square to "VISUAL."

3. Press ON SCREEN CONTROL \triangleleft / \triangleright to select a different video source.

- When you select "OSD," see page 49.

4. When you finish, press EXIT.

The menu disappears from the TV.

Using the DSP Modes (Also see pages 29, 32, 34, 37)

1. Press any button of ON SCREEN CONTROL Δ / ∇ / \triangleleft / \triangleright once.

The MAIN MENU appears on the TV.

2. Press ON SCREEN CONTROL Δ / ∇ to move \square to "MODE."

3. Press ON SCREEN CONTROL \triangleleft / \triangleright to select the DSP mode you want to use.

4. When you finish, press EXIT.

The menu disappears from the TV.

Note

The on-screen display will disappear if no operation is done for about one minute.

MAIN MENU

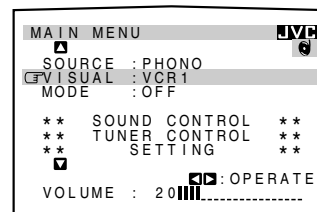

MAIN MENU

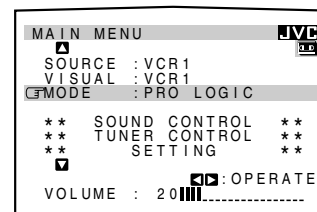

■ Adjusting the Front Speaker Output Balance (Also see page 18)

1. Press any button of ON SCREEN CONTROL $\Delta / \nabla / \triangleleft / \triangleright$ once.
The MAIN MENU appears on the TV.
2. Press ON SCREEN CONTROL Δ / ∇ to move $\left[\right]$ to "SOUND CONTROL," then press $\triangleleft / \triangleright$.
The SOUND CONTROL menu appears on the TV.
3. Press ON SCREEN CONTROL Δ / ∇ to move $\left[\right]$ to "BAL." (Balance).
4. Press ON SCREEN CONTROL $\triangleleft / \triangleright$ to adjust the balance.
5. When you finish, press EXIT repeatedly until the menu disappears from the TV.

■ Listening at Low Volume (Loudness) (Also see page 18)

1. Press any button of ON SCREEN CONTROL $\Delta / \nabla / \triangleleft / \triangleright$ once.
The MAIN MENU appears on the TV.
2. Press ON SCREEN CONTROL Δ / ∇ to move $\left[\right]$ to "SOUND CONTROL," then press $\triangleleft / \triangleright$.
The SOUND CONTROL menu appears on the TV.
3. Press ON SCREEN CONTROL Δ / ∇ to move $\left[\right]$ to "LOUDNESS."
4. Press ON SCREEN CONTROL $\triangleleft / \triangleright$ to turn the loudness "ON" or "OFF."
5. When you finish, press EXIT repeatedly until the menu disappears from the TV.

■ Attenuating the Input Signal (Also see page 15)

This function is available only for the sources connected using the analog terminals, and takes effect only when the DSP mode is in use.

1. Press any button of ON SCREEN CONTROL $\Delta / \nabla / \triangleleft / \triangleright$ once.
The MAIN MENU appears on the TV.
2. Press ON SCREEN CONTROL Δ / ∇ to move $\left[\right]$ to "SOUND CONTROL," then press $\triangleleft / \triangleright$.
The SOUND CONTROL menu appears on the TV.
3. Press ON SCREEN CONTROL Δ / ∇ to move $\left[\right]$ to "INPUT ATT."
4. Press ON SCREEN CONTROL $\triangleleft / \triangleright$ to turn the function on ("ATT ON") or off ("NORMAL").
5. When you finish, press EXIT repeatedly until the menu disappears from the TV.

MAIN MENU

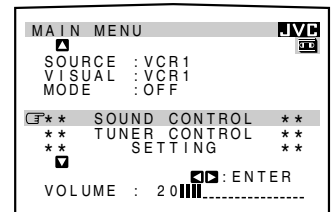

SOUND CONTROL menu

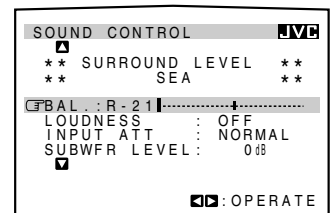

SOUND CONTROL menu

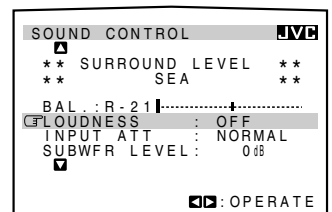

SOUND CONTROL menu

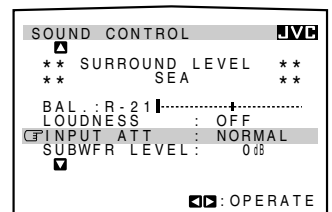

Using the On-Screen Menus

■ Adjusting the Subwoofer Output Level (Also see page 16)

You can adjust the subwoofer output level if you have selected “YES” for the “SUBWOOFER” (see page 18).

1. Press any button of ON SCREEN CONTROL Δ / ∇ / \triangleleft / \triangleright once.
The MAIN MENU appears on the TV.
2. Press ON SCREEN CONTROL Δ / ∇ to move \square to “SOUND CONTROL,” then press \triangleleft / \triangleright .
The SOUND CONTROL menu appears on the TV.
3. Press ON SCREEN CONTROL Δ / ∇ to move \square to “SUBWFR LEVEL” (Subwoofer Level).
4. Press ON SCREEN CONTROL \triangleleft / \triangleright to adjust the subwoofer output level.
5. When you finish, press EXIT repeatedly until the menu disappears from the TV.

■ Adjusting the DSP Modes (Also see pages 29, 32, 34, 37)

1. Press any button of ON SCREEN CONTROL Δ / ∇ / \triangleleft / \triangleright once.
The MAIN MENU appears on the TV.
2. Press ON SCREEN CONTROL Δ / ∇ to move \square to “MODE.”
3. Press ON SCREEN CONTROL \triangleleft / \triangleright to select the DSP mode you want to adjust.
4. Press ON SCREEN CONTROL Δ / ∇ to move \square to “SOUND CONTROL,” then press \triangleleft / \triangleright .
The SOUND CONTROL menu appears.
5. Press ON SCREEN CONTROL Δ / ∇ to move \square to “SURROUND LEVEL,” then press \triangleleft / \triangleright .
The SURROUND LEVEL menu appears.
 - If you select “HEADPHONE” in step 3, the SURROUND LEVEL menu will not appear.
6. Press ON SCREEN CONTROL Δ / ∇ to move \square to the item you want to set or adjust, then press ON SCREEN CONTROL \triangleleft / \triangleright .
On these adjustment menus, you can do the following:

For 3D-PHONIC modes:

“DSP EFFECT”:
Adjust the effect level.

For DAP modes (LIVE CLUB, DANCE CLUB, HALL, PAVILION):

“REAR L LEVEL”:
Adjust the left rear speaker output level. *

“REAR R LEVEL”:
Adjust the right rear speaker output level. *

“DSP EFFECT”:
Select the effect level.

MAIN MENU

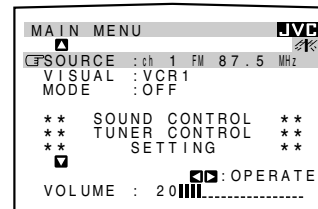

SOUND CONTROL menu

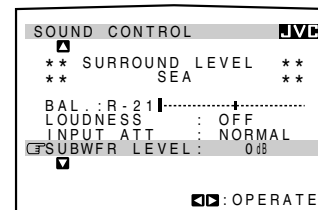

For Dolby Surround Pro Logic:

- “TEST TONE”: Output a test tone.
- “CENTER LEVEL”: Adjust the center speaker output level. **
- “REAR L LEVEL”: Adjust the left rear speaker output level. *
- “REAR R LEVEL”: Adjust the right rear speaker output level. *
- “CENTER TONE”: Select the center tone level. **

For Dolby Digital:

- “TEST TONE”: Output a test tone.
- “CENTER LEVEL”: Adjust the center speaker output level. **
- “REAR L LEVEL”: Adjust the left rear speaker output level. *
- “REAR R LEVEL”: Adjust the right rear speaker output level. *
- “CENTER TONE”: Select the center tone level. **

For Theater Surround and Digital Theater Surround:

- “TEST TONE”: Output a test tone.
- “CENTER LEVEL”: Adjust the center speaker output level. **
- “REAR L LEVEL”: Adjust the left rear speaker output level. *
- “REAR R LEVEL”: Adjust the right rear speaker output level. *
- “CENTER TONE”: Select the center tone level. **
- “DSP EFFECT”: Select the effect level. *

7. When you finish, press EXIT repeatedly until the menu disappears from the TV.

Selecting Your Favorite SEA Mode (Also see page 26)

1. Press any button of ON SCREEN CONTROL $\Delta / \nabla / \triangleleft / \triangleright$ once. The MAIN MENU appears on the TV.
2. Press ON SCREEN CONTROL Δ / ∇ to move $\left[\right]$ to “SOUND CONTROL,” then press $\triangleleft / \triangleright$. The SOUND CONTROL menu appears.
3. Press ON SCREEN CONTROL Δ / ∇ to move $\left[\right]$ to “SEA,” then press $\triangleleft / \triangleright$. The SEA menu appears.
4. Press ON SCREEN CONTROL Δ / ∇ to move $\left[\right]$ to “SEA MODE.”
5. Press ON SCREEN CONTROL $\triangleleft / \triangleright$ to select the SEA mode you want.
6. When you finish, press EXIT repeatedly until the menu disappears from the TV.

Example:
SURROUND LEVEL menu for Theater Surround

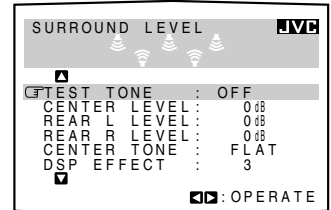

Notes:

- * Not displayed when “REAR SPK” is set to “NONE” (see page 19).
- ** Not displayed when “CENTER SPK” is set to “NONE” (see page 19).

MAIN MENU

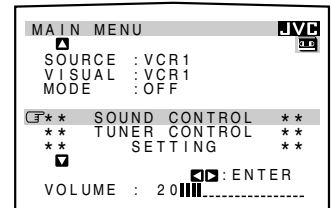

SOUND CONTROL menu

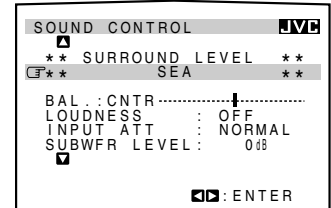

SEA menu

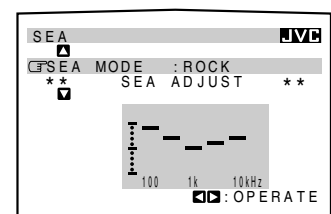

Using the On-Screen Menus

■ Creating Your Own SEA Mode (Also see page 27)

1. Press any button of ON SCREEN CONTROL $\Delta / \nabla / \triangleleft / \triangleright$ once.
The MAIN MENU appears on the TV.
2. Press ON SCREEN CONTROL Δ / ∇ to move \square to "SOUND CONTROL," then press $\triangleleft / \triangleright$.
The SOUND CONTROL menu appears.
3. Press ON SCREEN CONTROL Δ / ∇ to move \square to "SEA," then press $\triangleleft / \triangleright$.
The SEA menu appears.
4. Press ON SCREEN CONTROL Δ / ∇ to move \square to "SEA ADJUST," then press $\triangleleft / \triangleright$.
The SEA ADJUST menu appears.
5. Press ON SCREEN CONTROL $\Delta / \nabla / \triangleleft / \triangleright$ to adjust the SEA mode as you want.
 $\triangleleft / \triangleright$: Select the frequency ranges.
 Δ / ∇ : Adjust the frequency levels.
6. Press SET to store the setting into the SEA USERMODE.
 - If you press EXIT, without pressing SET in this step, you can return to the SEA menu. (The adjustment you have made is active but not stored.)
7. When you finish, press EXIT repeatedly until the menu disappears from the TV.

■ Basic Settings

1. Press any button of ON SCREEN CONTROL $\Delta / \nabla / \triangleleft / \triangleright$ once.
The MAIN MENU appears on the TV.
2. Press ON SCREEN CONTROL Δ / ∇ to move \square to "SETTING," then press $\triangleleft / \triangleright$.
The SETTING 1 or SETTING 2 menu appears.
3. Press ON SCREEN CONTROL Δ / ∇ to the setting item you want to adjust.
 - To go to the SETTING 2 menu, move \square to "NEXT PAGE," then press $\triangleleft / \triangleright$.
 - To go back to the SETTING 1 menu, move \square to "PREVIOUS PAGE," then press $\triangleleft / \triangleright$.

On the SETTING 1 and 2 menus, you can do the following:

- "SUBWOOFER": Set the subwoofer information (See page 18).
- "FRONT SPK": Set the front speaker information (See page 19).
- "CENTER SPK": Set the center speaker information (See page 19).
- "REAR SPK": Set the rear speaker information (See page 19).
- "CNTR DELAY": Adjust the delay time of the center speaker output (See page 20).
- "REAR DELAY": Adjust the delay time of the rear speaker output (See page 20).
- "CROSSOVER": Set the crossover frequency (See page 20).
- "LFE ATT.": Set the low frequency effect attenuator level (See page 21).
- "COMP.": Set the dynamic range compression (See page 21).
- "DIGITAL 1/2/3": Set the digital input terminal (See page 19).

MAIN MENU

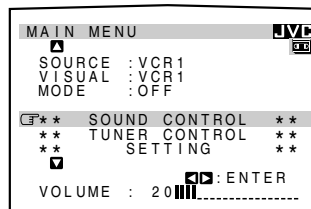

SOUND CONTROL menu

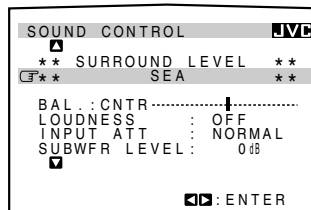

SEA menu

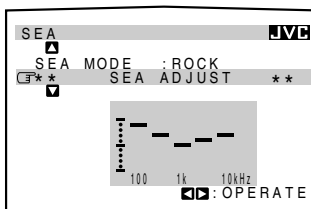

SEA ADJUST menu

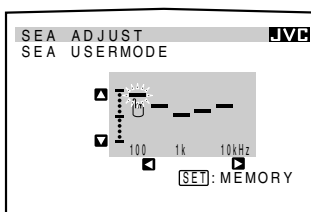

SETTING 1 menu

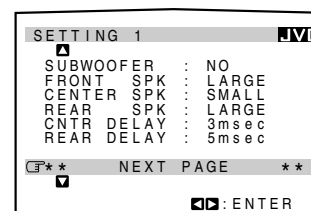

SETTING 2 menu

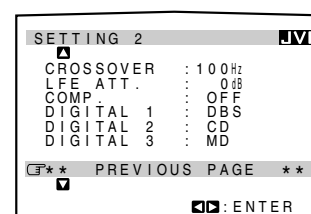

- Press ON SCREEN CONTROL $\triangle / \triangleright$ to set (or adjust) the setting item selected in step 3.
- When you finish, press EXIT repeatedly until the menu disappears from the TV.

■ Operating the Tuner

- Press any button of ON SCREEN CONTROL $\triangle / \nabla / \triangleleft / \triangleright$ once.
The MAIN MENU appears on the TV.
- Press ON SCREEN CONTROL \triangle / ∇ to move \square to "TUNER CONTROL," then press $\triangleleft / \triangleright$.
The TUNER CONTROL menu appears.
- Press ON SCREEN CONTROL \triangle / ∇ to move \square to the item you want to set or adjust, then press ON SCREEN CONTROL $\triangleleft / \triangleright$.
On the TUNER CONTROL menu, you can do the following:
 - "PRESET CH": Select a preset channel station. (See page 24)
 - "BAND": Select the band. (See page 23)
 - "FREQUENCY": Tune in a station manually. (See page 23)
 - "FM MODE": Select the FM reception mode. (See page 24) *
 - "PRESET MEMORY": See "Storing the Preset Stations" below.
- When you finish, press EXIT repeatedly until the menu disappears from the TV.

■ Storing the Preset Stations (Also see page 23)

- Press any button of ON SCREEN CONTROL $\triangle / \nabla / \triangleleft / \triangleright$ once.
The MAIN MENU appears on the TV.
- Press ON SCREEN CONTROL \triangle / ∇ to move \square to "TUNER CONTROL," then press $\triangleleft / \triangleright$.
The TUNER CONTROL menu appears.
- Tune into a station on the TUNER CONTROL menu, referring to "Operating the Tuner" above.
- Press ON SCREEN CONTROL \triangle / ∇ to move \square to "PRESET MEMORY," then press $\triangleleft / \triangleright$.
The PRESET MEMORY menu appears.
- Press ON SCREEN CONTROL \triangle / ∇ to move \square to "PRESET CH."
- Press ON SCREEN CONTROL $\triangleleft / \triangleright$ to select a preset station number you want.
- Press SET to store the setting.
- When you finish, press EXIT repeatedly until the menu disappears from the TV.

MAIN MENU

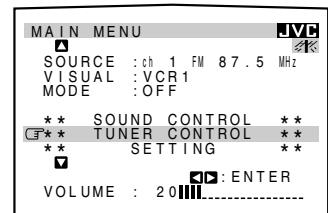

TUNER CONTROL menu

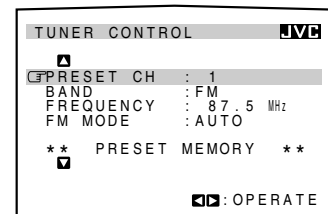

Note:

* Not displayed when an AM station is selected.

PRESET MEMORY menu

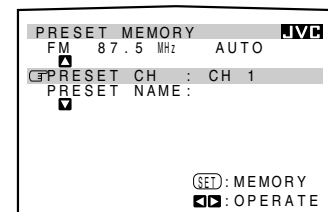

Using the On-Screen Menus

Assigning Names to the Preset Stations (Also see page 25)

- Press any button of ON SCREEN CONTROL $\Delta / \nabla / \triangleleft / \triangleright$ once.
The MAIN MENU appears on the TV.
- Press ON SCREEN CONTROL Δ / ∇ to move \square to "TUNER CONTROL," then press $\triangleleft / \triangleright$.
The TUNER CONTROL menu appears.
- Press ON SCREEN CONTROL Δ / ∇ to move \square to "PRESET CH."
- Press ON SCREEN CONTROL $\triangleleft / \triangleright$ to select a preset station.
- Press ON SCREEN CONTROL Δ / ∇ to move \square to "PRESET MEMORY," then press $\triangleleft / \triangleright$.
The PRESET MEMORY menu appears.
- Press ON SCREEN CONTROL Δ / ∇ to move \square to "PRESET NAME," then press SET.
The character entry screen appears.
- Press ON SCREEN CONTROL $\Delta / \nabla / \triangleleft / \triangleright$ to move \square in front of a character you want.
You can also select the following:
SPACE: To enter space CANCEL: To erase the character
 \triangleleft \triangleright : To go back to the previous character position or go to the next character position
- Press SET to enter the selected character.
- Repeat steps 7 and 8 to enter up to four characters.
- Press ON SCREEN CONTROL $\Delta / \nabla / \triangleleft / \triangleright$ to move \square to "PRESET NAME," then press SET to store the setting.
The TUNER CONTROL menu appears again.
- When you finish, press EXIT repeatedly until the menu disappears from the TV.

MAIN MENU

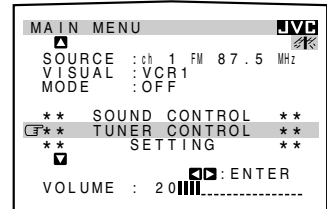

TUNER CONTROL menu

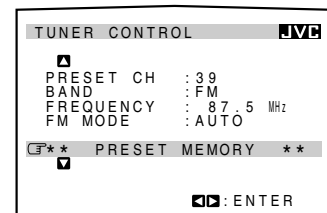

PRESET MEMORY menu

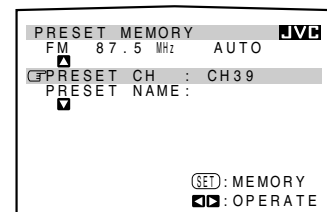

PRESET MEMORY menu: Character entry screen

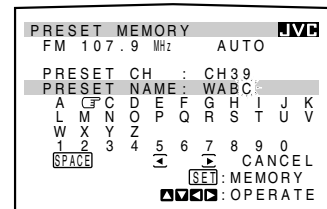
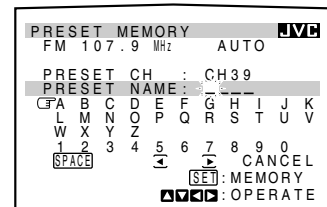

COMPU LINK Remote Control System

The COMPU LINK remote control system allows you to operate JVC audio components through the remote sensor on the receiver.

To use this remote control system, you need to connect JVC audio components through the COMPU LINK-3 (SYNCHRO) jacks (see below) in addition to the connections using cables with RCA pin plugs (see page 8) (and a digital cable if you want — see page 11).

- Make sure that the AC power cords of these components are unplugged before connection. Plug the AC power cords only after all connections are complete.

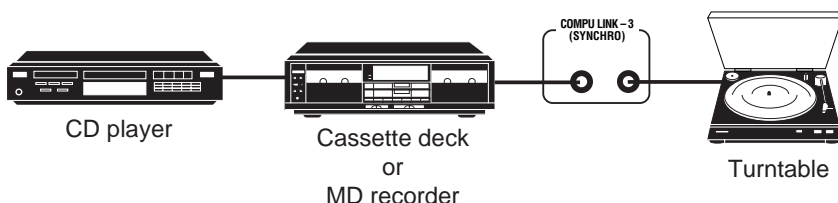

This remote control system allows you to use four functions listed below.

Remote Control through the Remote Sensor on the Receiver

You can control the connected audio components through the remote sensor on the receiver using this remote control. Aim the remote control directly at the remote sensor on the receiver. For details, see pages 58 and 59.

Automatic Source Selection

When you press the play (▶) button on a connected component or on its own remote control, the receiver automatically turns on and changes the source to the component. On the other hand, if you select a new source on the receiver or the remote control, the selected component begins playing immediately. In both cases, the previously selected source continues playing without sound for a few seconds.

Automatic Power On/Off (Standby): only possible with the COMPU LINK-3 connection

Both the CD player and cassette deck (or MD recorder) turn on and off (standby) along with the receiver.

When you turn on the receiver, the CD player or cassette deck (or MD recorder) will turn on automatically, depending on which component has been previously selected. When you turn off the receiver, both the CD player and cassette deck (or MD recorder) will turn off (standby).

Synchronized Recording

Synchronized recording means the cassette deck (or MD recorder) starts recording as soon as a CD or a record begins playing.

To use synchronized recording, follow these steps:

1. Put a tape in the cassette deck (or an MD in the MD recorder), and a disc in the CD player (or a record on the turntable).
2. Press the record (●) button and the pause (||) button on the cassette deck (or MD recorder) at the same time.

This puts the cassette deck (or MD recorder) into recording pause.

If you do not press the record (●) button and pause (||) button at the same time, the synchronized recording feature will not operate.

3. Press the play (▶) button on the CD player or on the turntable.

The source changes on the receiver, and as soon as play starts, the cassette deck (or MD recorder) starts recording. When the play ends, the cassette deck (or MD recorder) enters recording pause, and stops about 4 seconds later.

Notes:

- If your audio component has two COMPU LINK-3 (SYNCHRO) jacks, you can use either one. If it has only one COMPU LINK-3 (SYNCHRO) jack, connect it so that it is the last item in the series of components. (For example, the turntable or CD player in the diagram to the left.)
- To operate the cassette deck or MD recorder using the COMPU LINK remote control system, set the source name correctly. (See page 17.)
- Refer also to the manuals supplied with your audio components.

Notes:

- During synchronized recording, the selected source cannot be changed.
- If your CD player is playing in program mode, a 4-second blank is recorded between tracks so that the music scan feature of your cassette deck can be used on the recorded tape.
- If the power of any component is shut off during synchronized recording, the COMPU LINK remote control system may not operate properly. In this case, you must start again from the beginning.

TEXT COMPU LINK Remote Control System

The TEXT COMPU LINK remote control system has been newly developed to deal with the disc information recorded in the CD Text* and MDs. Using these information in the discs, you can operate the CD player or MD recorder equipped with the TEXT COMPU LINK remote control system through the receiver.

CONNECTIONS:

To use this remote control system, you need to connect the CD player and/or MD recorder you want to operate, following the procedures below.

1. If you have already plugged your CD player, MD recorder, and this receiver into the AC outlets, unplug their AC power cords first.
2. Connect your CD player, MD recorder, and this receiver as follows, through the COMPU LINK-3 (SYNCHRO) jacks and TEXT COMPU LINK jacks.

- 1) **COMPU LINK-3 (SYNCHRO) jacks:** Use the cables with the monaural mini-plugs (not supplied with this receiver)

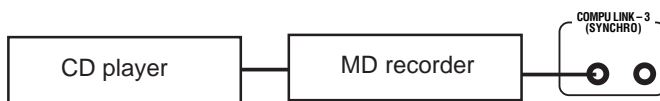

- 2) **TEXT COMPU LINK jacks:** Use the cables with the stereo mini-plugs (not supplied with this receiver)

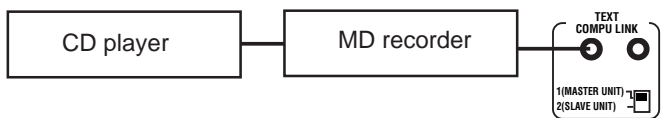

IMPORTANT:

Set the Master/Slave Selector on the rear to "1(MASTER UNIT)."

- "2(SLAVE UNIT)" is just for the serviceman's use. The TEXT COMPU LINK remote control system does not function with the selector set to "2(SLAVE UNIT)."

3. Connect your CD player, MD recorder and this receiver, using the cables with RCA pin plugs (see page 8) (and a digital cable if you want — see page 11).
4. Plug the AC power cords of these components above into the AC outlets.
5. When turning on these components for the first time, turn on the connected components first, then turn on this receiver.

FUNCTIONS:

This remote control system allows you to use the functions listed below.

Displaying the Disc Information on the TV screen

Disc information such as its performer and disc title (and track titles only when a CD Text is selected) is shown on the TV screen.

Disc Search: Only for CD Player

This remote control system can allow you to search discs by the performer, disc title, and music genre.

With this disc search, you can easily find the disc you want to play.

Additional Functions:

- If your CD player has the User File function, you can select a disc from the groups.
* A "user file" is a group of the discs you make as you like on the CD player.
- If your CD player has the disc memory function, you can input the performer, disc title, and music genre about these normal audio CDs on the TV screen.

* What is a CD Text?

In a CD Text, some information about the disc (its disc title, performer, composer, arranger, etc.) is recorded.

Notes:

- If your audio component has two COMPU LINK-3 (SYNCHRO) jacks, you can use either one. If it has only one COMPU LINK-3 (SYNCHRO) jack, connect it so that it is the last item in the series of components. (For example, the CD player in the diagram to the left.)
- If your audio component has two TEXT COMPU LINK jacks, you can use either one. If it has only one TEXT COMPU LINK jack, connect it so that it is the last item in the series of components. (For example, the CD player in the diagram to the left.)
- Refer also to the manuals supplied with your CD player or MD recorder.

Note:

If you turn on the receiver before turning on the other components after connecting components, the TEXT COMPU LINK remote control system does not work correctly.

If this happens:

1. Turn off the all components including this receiver.
2. Turn on the connected components.
3. Turn on this receiver.

OPERATIONS

To use this remote control system, you need to connect the TV to the MONITOR OUT jack on the rear panel (see page 9), and set the TV's input mode to the proper position to which the receiver is connected. **Make sure you have connected the CD player or MD recorder equipped with the TEXT COMPU LINK remote control system. If not, you cannot use the following functions.**

■ Showing the Disc Information on the TV Screen

1. Press any button of ON SCREEN CONTROL $\Delta / \nabla / \triangleleft / \triangleright$ once.
The MAIN MENU appears on the TV.
2. Press ON SCREEN CONTROL Δ / ∇ to move \square to "SOURCE."
3. Press ON SCREEN CONTROL $\triangleleft / \triangleright$ to select "CD" or "MD."
4. Press ON SCREEN CONTROL Δ / ∇ to move \square to "VISUAL."
5. Press ON SCREEN CONTROL $\triangleleft / \triangleright$ to select "OSD," then press EXIT.
The Disc Information screen appears on the TV.

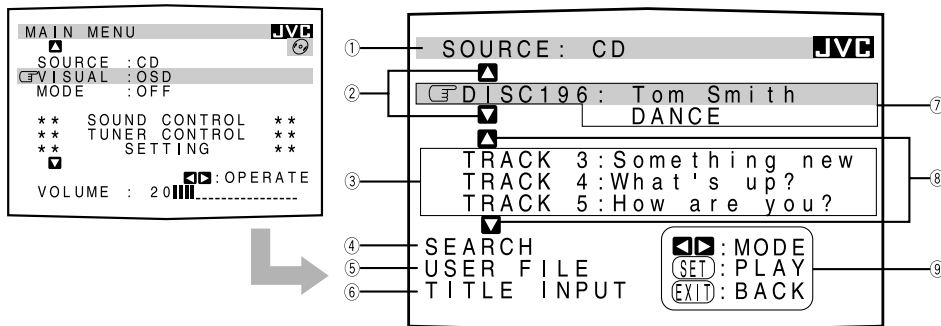

- ① Source name: CD or MD
- ② Select \blacktriangle or \blacktriangledown , then press SET to change the disc.
- ③ Track numbers and track titles.
 - The current playing (selected) track is indicated in yellow.
 - When you move \square to a track number, you can change the track information by pressing $\triangleleft / \triangleright$. Each time you press the button, the track information alternates between its track title and its performer. (You can also start playing the track by pressing SET.)
- ④ Select this (move \square in front), then press SET to go to the DISC SEARCH screen (see page 51).
- ⑤ Select this (move \square in front), then press SET to go to the USER FILE screen (see page 53).
- ⑥ Select this (move \square in front), then press SET to go to the TITLE INPUT screen (see page 54).
- ⑦ Disc information such as the disc title, performer, and music genre.
When this is selected (\square in front), you can change the disc information by pressing $\triangleleft / \triangleright$. Each time you press the button, the disc information (see the note) changes.
- ⑧ Select \blacktriangle or \blacktriangledown , then press SET to change the track.
- ⑨ Usable buttons and their functions for the current selection.
Indication here will be changed according to what is currently selected (\square in front) on the screen.

6. When you finish, press EXIT repeatedly until the MAIN MENU appears on the TV.

To exit from the MAIN MENU:

- 1) Press ON SCREEN CONTROL Δ / ∇ to move \square to "VISUAL."
- 2) Press ON SCREEN CONTROL $\triangleleft / \triangleright$ to select any one other than "OSD," then press EXIT.

Notes:

- The on-screen display will not appear about one minute after the power is turned on.
- The on-screen display will disappear in the following case:
 - if no operation is done for about 10 minutes.
 - if you do any operation other than explained in this section.
- To control the MD recorder using the TEXT COMPU LINK remote control system, you have to change the source name shown on the display from "TAPE" to "MD." (See page 17.)
- The number of characters to show the disc information such as the disc title or track title is limited to 32. So if the disc title, for example, is longer than 32 characters, only the first 32 characters are shown.
- Some special characters such as accented letters cannot be displayed correctly.

Note on ⑦

The following information will appear on the display:

- Disc title
- Performer
- Genre
- Song writer
- Composer
- Arranger
- Message

Only recorded information will be shown. If there is no data, "NO DATA" will appear.

Note on ⑨

For example, the SET button will be used to start play (PLAY), to go to the next screen (ENTER), and to determine the selection (ENTER).

TEXT COMPU LINK Remote Control System

■ Searching a Disc (Only for the CD player)

Search a disc by its performer:

1. Display the disc information screen by following the procedure on page 50.
2. Press ON SCREEN CONTROL Δ / ∇ to move \square to "SEARCH," then press SET.
The DISC SEARCH screen appears on the TV.
3. Press ON SCREEN CONTROL Δ / ∇ to move \square to "PERFORMER", then press SET.
The PERFORMER SEARCH screen appears.
4. Press ON SCREEN CONTROL $\Delta / \nabla / \triangleleft / \triangleright$ to move \square in front of the first character of the performer you want to search, then press SET.
To correct the incorrect entry, press ON SCREEN CONTROL Δ / ∇ to move \square in front of the correct character, then press SET.
To erase the incorrect entry, press ON SCREEN CONTROL Δ / ∇ to move \square to "CANCEL," then press SET.
5. Press SET again.
Disc search starts, then the SEARCH RESULT screen, showing the performers, appears.
6. On the SEARCH RESULT screen, you can do the following:
 - **Changing the indication of the disc information:** Press ON SCREEN CONTROL Δ / ∇ to move \square to a searched disc, then press $\triangleleft / \triangleright$. Each time you press $\triangleleft / \triangleright$, the disc information alternates between its performer and its disc title.
 - **Going to the Disc Information screen (see page 50):** Press ON SCREEN CONTROL Δ / ∇ to move \square to a searched disc, then press SET.
 - **Showing unseen disc information (if more than 5 discs are listed as a result of the search):** Press ON SCREEN CONTROL Δ / ∇ to move \square to \blacktriangledown (or \blacktriangle), then press SET.
 - **Going back to the PERFORMER SEARCH screen:** Press EXIT.

Search a disc by its disc title:

1. Display the disc information screen by following the procedure on page 50.
2. Press ON SCREEN CONTROL Δ / ∇ to move \square to "SEARCH," then press SET.
The DISC SEARCH screen appears on the TV.
3. Press ON SCREEN CONTROL Δ / ∇ to move \square "DISC TITLE", then press SET.
The DISC TITLE SEARCH screen appears.
4. Press ON SCREEN CONTROL $\Delta / \nabla / \triangleleft / \triangleright$ to move \square in front of the first character of the disc title you want to search, then press SET.
To correct the incorrect entry, press ON SCREEN CONTROL Δ / ∇ to move \square in front of the correct character, then press SET.
To erase the incorrect entry, press ON SCREEN CONTROL Δ / ∇ to move \square to "CANCEL," then press SET.

DISC SEARCH screen

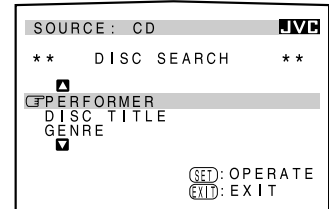

PERFORMER SEARCH screen

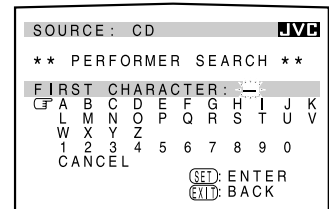

SEARCH RESULT screen

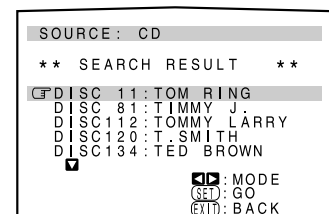

Note

Symbols such as @, # or \$ cannot be available for search.

DISC SEARCH screen

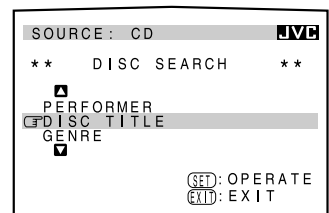

DISC TITLE SEARCH screen

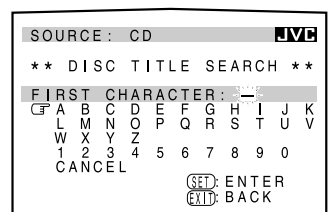

5. Press SET again.

Disc search starts, then the SEARCH RESULT screen, showing the disc titles, appears.

6. On the SEARCH RESULT screen, you can do the following:

- **Changing the indication of the disc information:** Press ON SCREEN CONTROL Δ / ∇ to move \square to a searched disc, then press $\triangleleft / \triangleright$. Each time you press $\triangleleft / \triangleright$, the disc information alternates between its disc title and its performer.
- **Going to the Disc Information screen (see page 50):** Press ON SCREEN CONTROL Δ / ∇ to move \square to a searched disc, then press SET.
- **Showing unseen disc information (if more than 5 discs are listed as a result of the search):** Press ON SCREEN CONTROL Δ / ∇ to move \square to \blacksquare (or \blacktriangle), then press SET.
- **Going back to the DISC TITLE SEARCH screen:** Press EXIT.

Search a disc by its genre:

1. Display the disc information screen by following the procedure on page 50.
2. Press ON SCREEN CONTROL Δ / ∇ to move \square to “SEARCH,” then press SET.
The DISC SEARCH screen appears on the TV.
3. Press ON SCREEN CONTROL Δ / ∇ to move \square to “GENRE”, then press SET.
The GENRE SEARCH screen appears.
4. Press ON SCREEN CONTROL Δ / ∇ to move \square to the genre you want to search, then press SET.

To show the unseen genres, press ON SCREEN CONTROL Δ / ∇ until they appear.

Disc search starts, then the SEARCH RESULT screen, showing the disc titles, appears.

5. On the SEARCH RESULT screen, you can do the following:

- **Changing the indication of the disc information:** Press ON SCREEN CONTROL Δ / ∇ to move \square to a searched disc, then press $\triangleleft / \triangleright$. Each time you press $\triangleleft / \triangleright$, the disc information alternates between its disc title and its performer.
- **Going to the Disc Information screen (see page 50):** Press ON SCREEN CONTROL Δ / ∇ to move \square to a searched disc, then press SET.
- **Showing unseen disc information (if more than 5 discs are listed as a result of the search):** Press ON SCREEN CONTROL Δ / ∇ to move \square to \blacksquare (or \blacktriangle), then press SET.
- **Going back to the GENRE SEARCH screen:** Press EXIT.

SEARCH RESULT screen

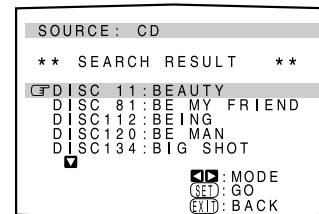

Note

Symbols such as @, # or \$ cannot be available for search.

GENRE SEARCH screen

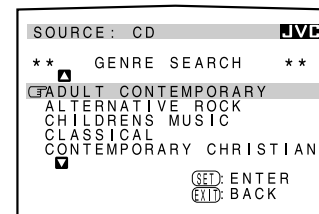

SEARCH RESULT screen

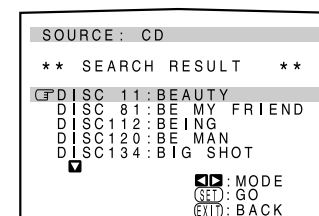

■ Using the User File (Only for the CD Player with the User File Function)

You can use the User File function through this receiver.

For the User File function, refer to the manual supplied with your CD player.

Using your own User Files:

1. Display the disc information screen by following the procedure on page 50.
2. Press ON SCREEN CONTROL Δ / ∇ to move \square to "USER FILE," then press SET.
The USER FILE screen appears on the TV.
To show the unseen user files, press ON SCREEN CONTROL Δ / ∇ until they appear.
3. Press ON SCREEN CONTROL Δ / ∇ to move \square to the User File you want, then press SET.
The selected User File screen appears on the TV.
The disc information shown will be the disc title. (If no disc title information is recorded for the discs, only the disc numbers will be shown.)
4. On this selected User File screen, you can do the following:
 - **Changing the indication of the disc information:** Press ON SCREEN CONTROL Δ / ∇ to move \square to a disc, then press $\triangleleft / \triangleright$. Each time you press $\triangleleft / \triangleright$, the disc information alternates between its disc title and its performer.
 - **Starting a disc play:** Press ON SCREEN CONTROL Δ / ∇ to move \square to a disc, then press SET.
 - **Showing unseen disc information** (if more than 5 discs are listed): Press ON SCREEN CONTROL Δ / ∇ to move \square to \blacksquare (or \blacktriangle) and press SET.
 - **Going back to the USER FILE screen:** Press EXIT.

USER FILE screen

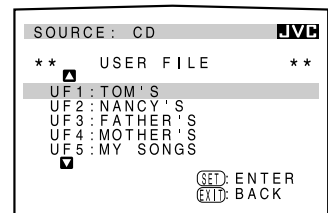

User File 1 screen

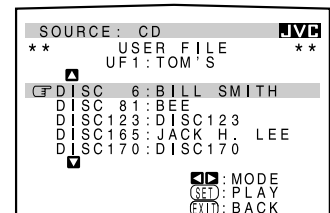

■ Entering the Disc Information

For the CD Player with the disc memory function:

You can use the disc memory function through this receiver.

The disc information (its performer, disc title, and its music genre) of normal audio CDs will be stored into the memory built in the CD player.

For the disc memory function, refer to the manual supplied with your CD player.

- The performer, disc title, and music genre information are usually recorded in a CD Text. However, if a CD Text has no genre information recorded in the disc itself, you can input its music genre by yourself.

Note: You can enter the TITLE INPUT screens for a CD Text and input its titles.

However, **you cannot store the titles you have input for a CD Text.**

Example: Entering the following information for Disc 1
Performer: "MICHEAL"
Disc title: "MY FAVORITE"

1. Display the disc information screen by following the procedure on page 50.
2. Press ON SCREEN CONTROL Δ / ∇ to move ⏏ to "TITLE INPUT," then press SET.

The TITLE INPUT: PERFORMER screen appears on the TV.

3. Press ON SCREEN CONTROL $\Delta / \nabla / \triangleleft / \triangleright$ to move ⏏ in front of a character you want, then press SET to enter the character.

- If the current CD is a CD Text, go to step 5 without entering the performer.

To use the lower case letters, press ON SCREEN CONTROL $\Delta / \nabla / \triangleleft / \triangleright$ to move ⏏ to [SHIFT] , then press SET.

To use the upper case letters again, press ON SCREEN CONTROL $\Delta / \nabla / \triangleleft / \triangleright$ to move ⏏ to [SHIFT] , then press SET.

4. Repeat step 3 until you finish putting a name (up to 32 characters) to this User File.

To insert a space, press ON SCREEN CONTROL $\Delta / \nabla / \triangleleft / \triangleright$ to move ⏏ to [SPACE] , then press SET.

To correct an incorrect character:

- 1) Press ON SCREEN CONTROL $\Delta / \nabla / \triangleleft / \triangleright$ to move ⏏ to ◀ or ▶ , then press SET until the incorrect character is selected.
 - 2) Press ON SCREEN CONTROL $\Delta / \nabla / \triangleleft / \triangleright$ to move ⏏ to CANCEL, then press SET to erase the character.
 - 3) Press ON SCREEN CONTROL $\Delta / \nabla / \triangleleft / \triangleright$ to move ⏏ in front of an correct character, then press SET to enter a correct character.
5. Press ON SCREEN CONTROL $\Delta / \nabla / \triangleleft / \triangleright$ to move ⏏ to "DISC1: MICHEAL (in this example)," then press SET.

The TITLE INPUT: DISC TITLE screen appears.

6. Enter the disc title, referring to steps 3 and 4.

- If the current CD is a CD Text, go to the next step without entering the disc title.

TITLE INPUT: PERFORMER screen

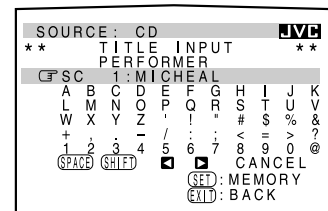
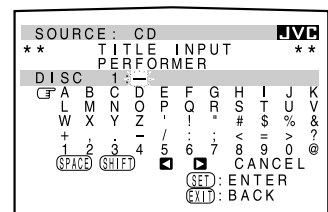

TITLE INPUT: DISC TITLE screen

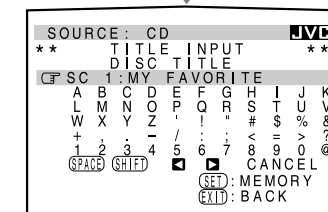
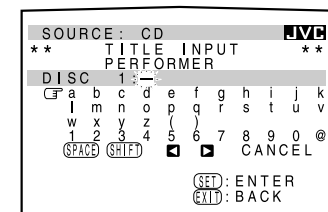
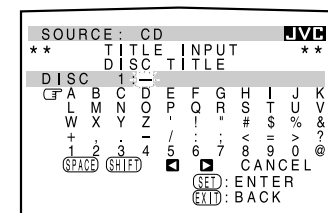

Continued to the next page.

TEXT COMPU LINK Remote Control System

7. Press ON SCREEN CONTROL $\Delta / \nabla / \triangleleft / \triangleright$ to move F to “DISC1: MY FAVORITE (in this example),” then press SET.

The TITLE INPUT: DISC 1 GENRE screen appears.

8. Press ON SCREEN CONTROL Δ / ∇ to move F to the genre you want, then press SET.

The Disc Information screen appears again.

To show the unseen genres, press ON SCREEN CONTROL Δ / ∇ until they appear.

For the MD recorder:

You can write the disc information (disc title and song titles) into the disc. You can only write the song title for the song currently selected.

- If you have the CD-MD combination deck, you can also enter the disc information (its performer, disc title, and its music genre) of normal audio CDs into the memory built in the CD-MD combination deck. (To do this, follow the procedure on page 54.)

1. Display the disc information screen by following the procedure on page 50.
2. Press ON SCREEN CONTROL Δ / ∇ to move F to “TITLE INPUT,” then press SET.
The DISC TITLE INPUT screen appears on the TV.
3. Enter the disc title, referring to steps 3 and 4 on page 54.
 - You can enter up to 32 character for the disc title.
4. Press ON SCREEN CONTROL $\Delta / \nabla / \triangleleft / \triangleright$ to move F to the disc title you have just entered, then press SET.
The disc title is stored into the memory, and the SONG TITLE INPUT screen for the currently selected song appears.
 - You can enter a song title for the song currently selected (indicated in yellow on the TV screen).
5. Enter the song title, referring to steps 3 and 4 on page 54.
 - You can enter up to 32 character for the song title.
6. Press ON SCREEN CONTROL $\Delta / \nabla / \triangleleft / \triangleright$ to move F to the song title you have just entered, then press SET.
The song title is stored into the memory, and the Disc Information screen appears again.

TITLE INPUT: DISC 1 GENRE screen

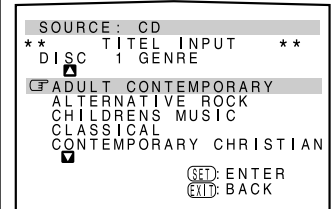

Disc Information screen

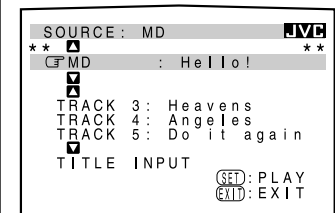

DISC TITLE INPUT screen

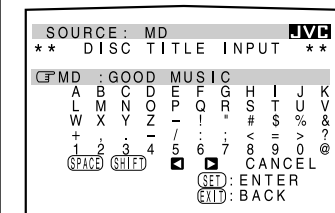
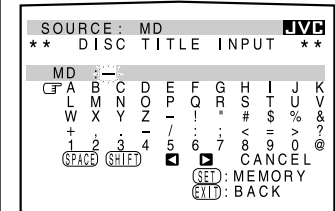

AV COMPU LINK Remote Control System

The AV COMPU LINK remote control system allows you to operate JVC video components (TV, VCR, and DVD player) through the receiver.

CONNECTIONS:

To use this remote control system, you need to connect the video components you want to operate, following the procedures below.

1. If you have already plugged your VCR1 (the VCR connected to the VCR 1 jacks), DVD player, TV, and this receiver into the AC outlets, unplug their AC power cords first.
2. Connect your VCR1, DVD player, TV, and this receiver as follows, using the cables with the monaural mini-plugs (not supplied).

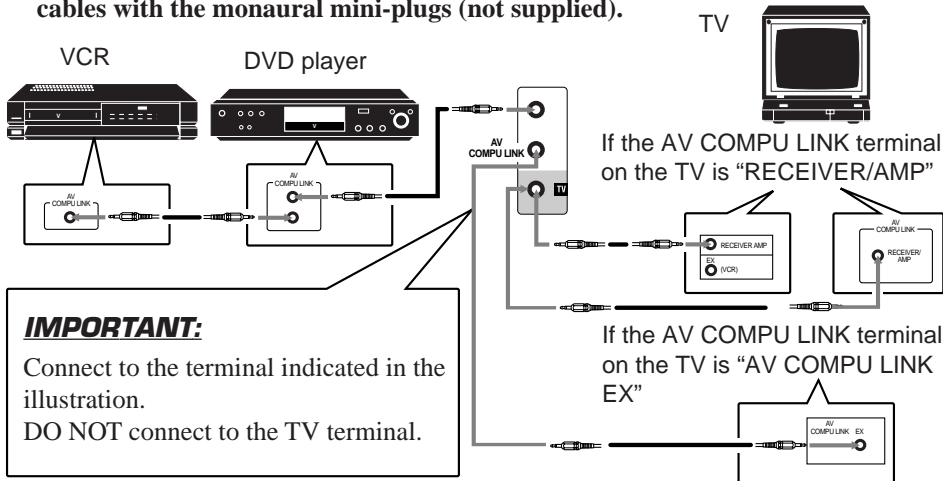

3. Connect the audio input/output jacks on VCR1, DVD player, TV, and this receiver using the cables with RCA pin plug (see pages 9 to 10) (and a digital cable if you want — see page 11).
4. Connect the video input/output jacks on VCR1, DVD player, TV, and this receiver as follows, using the cables with RCA pin plug or with S-video plug.

CAUTION:

The AV COMPU LINK remote control system cannot control the DBS tuner connected to the TV/DBS jacks, and video components connected to the VIDEO and VCR2 jacks on the receiver.

Note:

When connecting either the VCR or DVD player to this receiver, connect it directly to the receiver using cable with the monaural mini-plugs.

CASE1: If the components are equipped with the S-video terminals

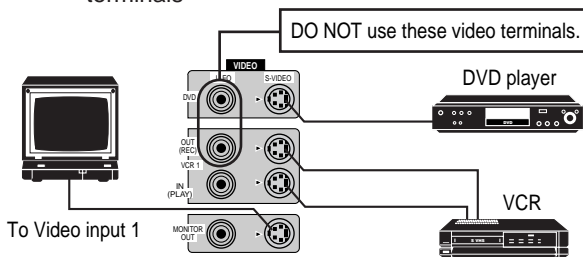

CASE2: If the components are not equipped with the S-video terminals

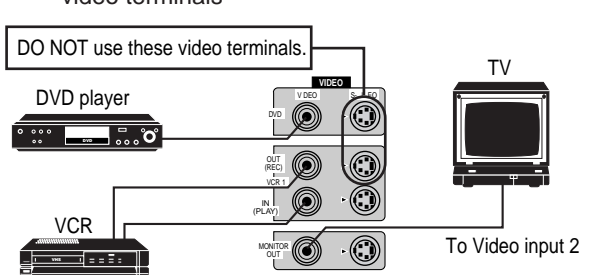

CASE3: If only the VCR is equipped with the S-video terminal.

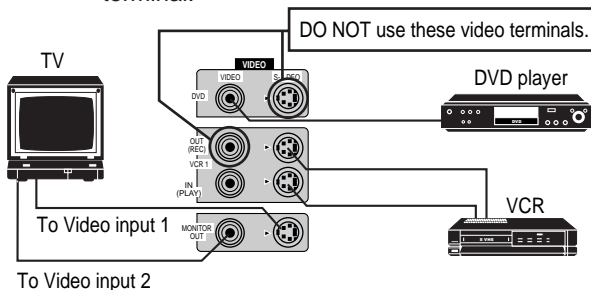

CASE4: If only the DVD player is equipped with the S-video terminal.

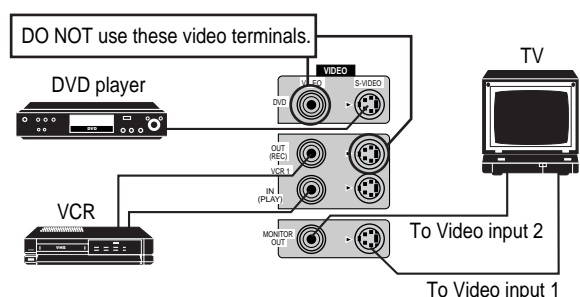

5. Plug the AC power cords of the components into the AC outlets.
6. When turning on the TV for the first time after the AV COMPU LINK connection, turn the TV volume to the minimum using the TV volume control on the TV.

FUNCTIONS:

This remote control system allows you to use five functions listed below.

Remote Control of DVD Player, VCR, and TV Using This Remote Control

For the DVD player and the VCR:

- Aim the remote control directly at **the remote sensor on the each component.**

For the TV having AV COMPU LINK terminal “RECEIVER/AMP”:

- Aim the remote control directly at **the remote sensor on the receiver when operating the TV.**

For the TV having AV COMPU LINK terminal “AV COMPU LINK EX”:

- Aim the remote control directly at **the remote sensor on the TV when operating the TV.**

One-Touch Video Play

Simply by inserting a video cassette without its safety tab into the VCR1 (the VCR connected to the VCR1 jacks), you can enjoy the video playback without setting other switches manually.

The receiver automatically turns on and changes the source to “VCR1.”

The TV automatically turns on and changes the input mode to the position so that you can view the playback picture.

When you insert a video cassette with its safety tab, press the play (▶) button on the VCR1 or on the remote control. So, you can get the same result.

One-Touch DVD Play

Simply by starting playback on the DVD player, you can enjoy the DVD playback without setting other switches manually.

The receiver automatically turns on and changes the source to “DVD”— “DVD” is automatically selected.

The TV automatically turns on and changes the input mode to the position so that you can view the playback picture.

Automatic Selection of TV's Input Mode

- When you select “TV SOUND” as the source to play on the receiver, the TV automatically changes the input mode to the TV tuner so that you can watch TV.
- When you select “VCR2,” as the source to play on the receiver, the TV automatically changes the input mode to the Video Input 2 so that you can watch the playback picture.
- When you select “DVD,” “VCR1,” “VIDEO” or “DBS” as the source to play on the receiver, the TV automatically changes the input mode to the appropriate position (either Video Input 1 or Video Input 2) so that you can view the playback picture.

Automatic Power On/Off (Standby)

The TV, VCR1 (the VCR connected to the VCR1 jacks), and DVD player turn on and off along with the receiver.

- When you turn on the receiver;
 - If the previously selected source is “VCR1,” the TV and VCR1 will turn on automatically.
 - If the previously selected source is “VIDEO” or “TV SOUND,” only the TV will turn on automatically.
 - If the previously selected source is “DVD,” the TV and DVD player will turn on automatically.

When you turn off the receiver, the TV, VCR1 and the DVD player will turn off.

Note:

Refer also to the manuals supplied with your video components.

Note:

When you select “TV SOUND” as the source on the receiver, you cannot see the menu on the TV screen since the AV COMPU LINK remote control system automatically changes the TV's input mode to the TV tuner. If you do not mind stopping listening to the TV sounds, you can then show the on-screen displays after changing the TV's input mode to the appropriate position (either Video Input 1 or Video Input 2) the receiver is connected to.

Note:

If you turn off the receiver while recording on the VCR1, the VCR1 will not turn off, but continue recording.

Operating JVC's Audio/Video Components

You can operate JVC's audio and video components with this receiver's remote control, since control signals for JVC components are preset in the remote control.

IMPORTANT:

To operate JVC's audio components using this remote control:

- You need to connect JVC audio components through the COMPU LINK-3 (SYNCHRO) jacks (see page 48) in addition to the connections using cables with RCA pin plugs (see page 8) or using digital cables (see page 11).
- Aim the remote control directly at the remote sensor on the receiver.

Tuner

After pressing FM or AM (with the remote control mode selector set to "AUDIO/TV/VCR"), you can perform the following operations:

- FM:** Selects an FM broadcast.
AM: Selects an AM broadcast.
1 — 10, +10: Selects a preset channel number directly. For channel number 5, press 5. For channel number 15, press +10, then 5. For channel number 20, press +10, then 10.

TUNING UP/TUNING DOWN:

Tunes into stations.

FM MODE/MUTE: Changes the FM reception mode.

Sound control section (Amplifier)

You can always perform the following operations (with the remote control mode selector set to "AUDIO/TV/VCR"):

SURROUND MODE: Changes the DSP modes.

After pressing SOUND (with the remote control mode selector set to "AUDIO/TV/VCR"), you can perform the following operations:

- SEA MODE:** Changes the SEA modes.
SUBWOOFER +/-: Adjusts the subwoofer output level.
CNTR +/-: Adjusts the center speaker output level.
REAR•L +/-: Adjusts the left rear speaker output level.
REAR•R +/-: Adjusts the right rear speaker output level.
EFFECT: Selects the effect level.
TEST: Turns on or off the test tone output.
CNTR TONE: Selects the center tone.

CD player

After pressing CD (with the remote control mode selector set to "AUDIO/TV/VCR"), you can perform the following operations on a CD player:

- PLAY:** Starts playing.
◀◀: Returns to the beginning of the current (or previous) track.
▶▶: Skips to the beginning of the next track.
STOP: Stops playing.
PAUSE: Pauses playing. To release it, press PLAY.
1 — 10, +10: Selects a track number directly. For track number 5, press 5. For track number 15, press +10, then 5. For track number 20, press +10, then 10. For track number 30, press +10, +10, then 10.

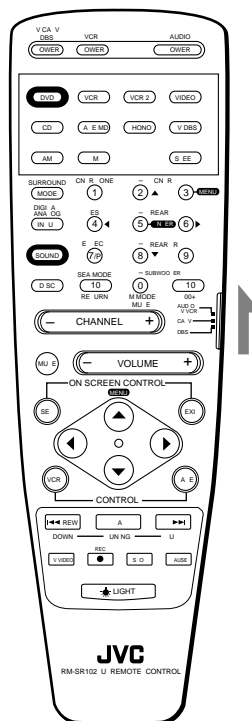

Notes:

- If you use the buttons on the front panel or the menu function to choose a source, the remote control will not operate that source. To operate a source with the remote control, the source must be selected using buttons on the remote control.
- Check to see if its remote control mode selector is set to the correct position. To operate audio system, TVs, and VCRs, set it to "AUDIO/TV/VCR."
- Refer also to the manuals supplied with your components.

Note:

After adjusting sounds, press the corresponding source selecting button or DISC to operate your target source by using 10 keys; otherwise, 10 keys cannot be used for operating your target source.

Operating JVC's Audio/Video Components

CD player-changer

After pressing DISC (with the remote control mode selector set to "AUDIO/TV/VCR"), you can perform the following operations on the CD player-changer:

- PLAY:** Starts playing.
- ◀◀:** Returns to the beginning of the current (or previous) track.
- ▶▶:** Skips to the beginning of the next track.
- STOP:** Stops playing.
- PAUSE:** Pauses playing. To release it, press the PLAY button.
- 1 — 6, 7/P:** Select the number of a disc installed in a CD player-changer.

After pressing CD (with the remote control mode selector set to "AUDIO/TV/VCR"), you can perform the following operations on the CD player-changer:

- 1 — 10, +10:** Selects a track number directly. For track number 5, press 5. For track number 15, press +10, then 5. For track number 20, press +10, then 10. For track number 30, press +10, +10, then 10.

Turntable

After pressing PHONO (with the remote control mode selector set to "AUDIO/TV/VCR"), you can perform the following operations on the turntable:

- PLAY:** Starts playing.
- STOP:** Stops playing.

Cassette deck

After pressing TAPE/MD or TAPE CONTROL (with the remote control mode selector set to "AUDIO/TV/VCR"), you can perform the following operations on the cassette deck:

- PLAY:** Starts playing.
- REW:** Fast winds the tape from right to left.
- FF:** Fast winds the tape from left to right.
- STOP:** Stops operations.
- PAUSE:** Pauses playing or recording temporarily. To release it, press the PLAY button.
- REC ●:** Press this button with the PLAY button to start recording. Press this button with the PAUSE button to enter recording pause.

MD recorder

After pressing TAPE/MD or TAPE CONTROL (with the remote control mode selector set to "AUDIO/TV/VCR"), you can perform the following operations on the MD recorder:

- PLAY:** Starts playing.
- ◀◀:** Returns to the beginning of the current (or previous) track.
- ▶▶:** Skips to the beginning of the next track.
- STOP:** Stops playing.
- PAUSE:** Pauses playing. To release it, press the PLAY button.
- REC ●:** Press this button with the PLAY button to start recording. Press this button with the PAUSE button to enter recording pause.

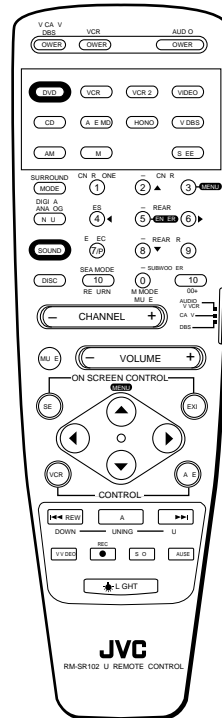

Notes:

- To operate the cassette deck or MD recorder using the COMPU LINK remote control system, set the source name correctly. (See page 17.)
- You can use either the TAPE/MD button or the TAPE CONTROL button to activate the buttons listed to the left. If you press TAPE/MD, the playing source also changes. On the other hand, if you press TAPE CONTROL, the playing source does not change.

IMPORTANT:

To operate JVC's video components using this remote control:

- You need to connect JVC video components through the AV COMPU LINK jacks (see page 56) in addition to the connections using cables with RCA pin plugs (see pages 9 to 10) or using a digital cable (see page 11).
- **When using the remote control:**
 - For the DVD player and the VCR: Aim the remote control directly at the **remote sensor on the each component.**
 - For the TV having AV COMPU LINK terminal "RECEIVER/AMP": Aim the remote control directly at the **remote sensor on the receiver when operating the TV.**
 - For the TV having AV COMPU LINK terminal "AV COMPU LINK EX": Aim the remote control directly at the **remote sensor on the TV when operating the TV.**

VCR1 (the VCR connected to the VCR1 jacks)

You can always perform the following operations (with the remote control mode selector set to "AUDIO/TV/VCR"):

VCR1 POWER: Turns on or off the VCR1.

After pressing VCR1 or VCR1 CONTROL (with the remote control mode selector set to "AUDIO/TV/VCR"), you can perform the following operations on the VCR:

- PLAY:** Starts playing.
REW: Rewinds a tape.
FF: Fast winds a tape.
STOP: Stops operations.
PAUSE: Pauses playing or recording temporarily. To release it, press the PLAY button.
REC ●: Press this button with the PLAY button to start recording.
Press this button with the PAUSE button to enter recording pause.
CHANNEL +/-: Changes the channels on the VCR.
1 - 9, 0: Selects the channels on the VCR.
For channel 5, press 5.
For channel 10, press 1, then 0.

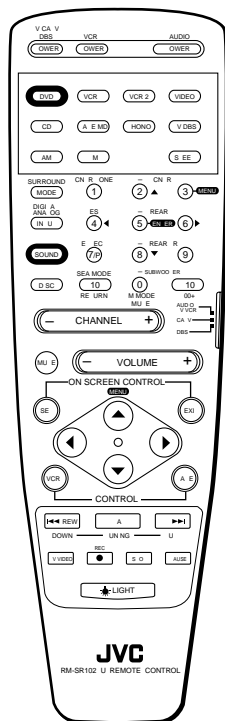

Notes:

- Some JVC VCRs can accept two types of the control signals – code "A" and "B." Before using this remote control, make sure that the remote control code of the VCR1 is set to code "A."
- You can use either the VCR1 CONTROL button or the VCR1 button to activate the buttons listed to the left. If you press VCR1, the playing source also changes. On the other hand, if you press VCR1 CONTROL, the playing source does not change.

DVD player

After pressing DVD (with the remote control mode selector set to "AUDIO/TV/VCR"), you can perform the following operations on a DVD player:

- PLAY:** Starts playing.
◀◀: Returns to the beginning of the current (or previous) track.
▶▶: Skips to the beginning of the next track.
STOP: Stops playing.
PAUSE: Stops playing temporarily. To release it, press the PLAY button.

After pressing DVD (with the remote control mode selector set to the "AUDIO/TV/VCR" position), these buttons can be used for the DVD menu operations.

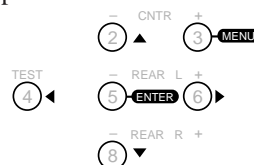

Note:

For detailed menu operations, refer to the instructions supplied with the discs or the DVD player.

Operating JVC's Audio/Video Components

TV

You can always perform the following operations (*with the remote control mode selector set to "AUDIO/TV/VCR"*):

TV/CATV/DBS POWER: Turns on or off the TV.

TV/VIDEO: Sets the input mode (either TV or VIDEO).

After pressing TV/DBS (*with the remote control mode selector set to "AUDIO/TV/VCR"*), you can perform the following operations on a TV:

CHANNEL +/-: Changes the channels.

1 – 9, 0, 100+: Selects the channels.

RETURN: Alternates between the previously selected channel and the current channel.

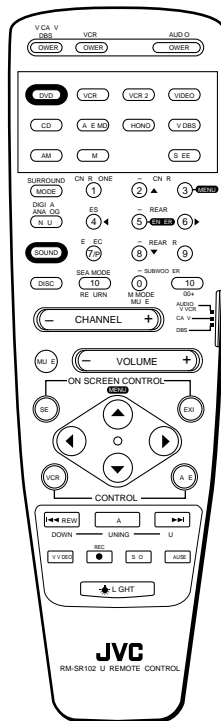

When the TV is connected to the TV SOUND/DBS jacks on the rear:
 The receiver automatically turns on and select "TV SOUND" as the source about 5 seconds after you turn on the TV. (If you change the source name from "TV SOUND" to "DBS," the receiver will not turn on along with the TV. See page 17)

Note:
 When you turn off the receiver with the TV kept turned on, the receiver will turn on soon again. To prevent this from happening, make sure that you turn off the TV before turning off the receiver.

Operating Other Manufacturers' Components

This remote control supplied with the receiver can transmit control signals for other manufacturers' VCRs, TVs, CATV converters and DBS tuners. By changing the transmittable signals from preset ones to the other manufacturers', you can operate the other manufacturer's components using this remote control.

When operating the other manufacturers' components, refer also to the manuals supplied with them.

To operate these components with the remote control, first you need to set the manufacturer's code each for the VCR, TV, CATV converter, and DBS tuner.

IMPORTANT:

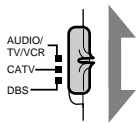

When using the Remote Control, check to see if its remote control mode selector is set to the correct position:
To operate an audio system, TV, and VCR, set it to "AUDIO/TV/VCR."
To operate a CATV converter, set it to "CATV."
To operate a DBS tuner, set it to "DBS."

To change the transmittable signals for operating another manufacturer's TV

1. Set the remote control mode selector to "AUDIO/TV/VCR."
2. Press and hold TV/CATV/DBS POWER.
3. Press TV/DBS.
4. Enter the manufacturer's code (three digits) using buttons 1 – 9, and 0.
See the lists on page 65 to find the code.
5. Release TV/CATV/DBS POWER.

The following buttons can be used for operating the TV (with the remote control mode selector set to "AUDIO/TV/VCR"):

TV/CATV/DBS POWER: Turns on and off TV.

TV/VIDEO: Sets the input mode (either TV or VIDEO).

After pressing TV/DBS (with the remote control mode selector set to "AUDIO/TV/VCR"), you can perform the following operations on the TV:

CHANNEL +/-: Changes the channels.

1 – 10, 0, 100+(+10): Selects the TV channels.
100+(+10) button will function as the ENTER button if your TV requires pressing ENTER after selecting a channel number.

6. Try to operate your TV by pressing TV/CATV/DBS POWER.

When your TV turns on or off, you have entered the correct code.

7. If there are more than one code listed for your brand of TV, try each one until the correct one is entered.

When the TV is connected to the TV SOUND/DBS jacks on the rear:

The receiver automatically turns on and select "TV SOUND" as the source about 5 seconds after you turn on the TV. (If you change the source name from "TV SOUND" to "DBS," the receiver will not turn on along with the TV. See page 17)

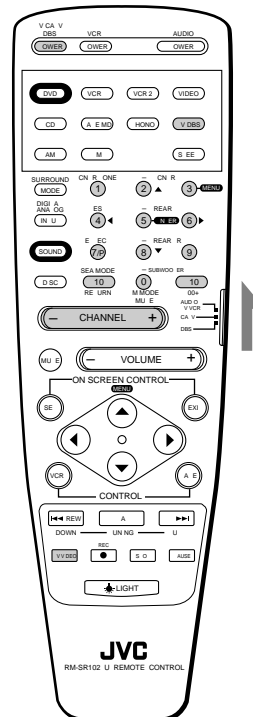

Note:

Refer also to the manual supplied with your TV.

Note:

When you turn off the receiver with the TV kept turned on, the receiver will turn on soon again. To prevent this from happening, make sure that you turn off the TV before turning off the receiver.

Operating Other Manufactures' Components

To change the transmittable signals for operating a CATV converter or DBS tuner

1. For the CATV converter:

Set the remote control mode selector to "CATV."

For the DBS tuner:

Set the remote control mode selector to "DBS."

2. Press and hold TV/CATV/DBS POWER.

3. Press TV/DBS.

4. Enter the manufacturer's code (three digits) using buttons 1 – 9, and 0.

See the lists on page 66 to find the code.

5. Release TV/CATV/DBS POWER.

After setting the remote control mode selector to "CATV" or "DBS," you can perform the following operations on the CATV converter or on the DBS tuner:

TV/CATV/DBS POWER: Turns on and off the CATV converter or DBS tuner.

CHANNEL +/-: Changes the channels.
1 – 10, 0, 100+(+10): Selects the channels.
 100+(+10) button will function as the ENTER button if your CATV converter or DBS tuner requires pressing ENTER after selecting a channel number.

6. Try to operate your CATV converter or DBS tuner by pressing TV/CATV/DBS POWER.

When your CATV converter or DBS tuner turns on or off, you have entered the correct code.

7. If there are more than one code listed for your brand of CATV converter or DBS tuner, try each one until the correct one is entered.

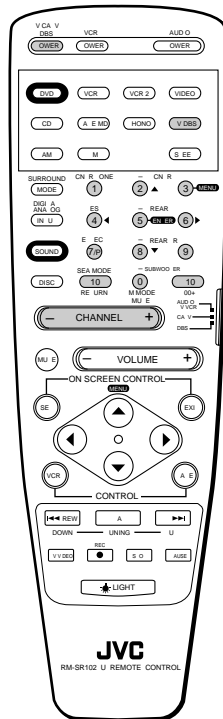

Note:
 Refer also to the manual supplied with your CATV converter or DBS tuner.

To change the transmittable signals for operating another manufacturer's VCR

1. Set the remote control mode selector to "AUDIO/TV/VCR."
2. Press and hold VCR1 POWER.
3. Press VCR1.
4. Enter the manufacturer's code (three digits) using buttons 1 – 9, and 0.
See the lists on pages 66 and 67 to find the code.
5. Release VCR1 POWER.

The following buttons can be used for operating the VCR (with the remote control mode selector set to "AUDIO/TV/VCR"):

VCR1 POWER: Turns on and off VCR.

After pressing VCR1 or VCR1 CONTROL (with the remote control mode selector set to "AUDIO/TV/VCR"), you can perform the following operations on the VCR:

CHANNEL +/-: Changes the channels on the VCR.

1 – 10, 0, 100+(+10): Selects the channels on the VCR. 100+(+10) button will function as the ENTER button if your VCR requires pressing ENTER after selecting a channel number.

PLAY: Starts playback.
STOP: Stops operations.
PAUSE: Pauses.
REW: Rewinds a tape.
FF: Fast winds a tape.
REC ●: Starts recording or enters recording pause.

6. Try to operate your VCR by pressing VCR1 POWER.
When your VCR turns on or off, you have entered the correct code.
7. If there are more than one code listed for your brand of VCR, try each one until the correct one is entered.

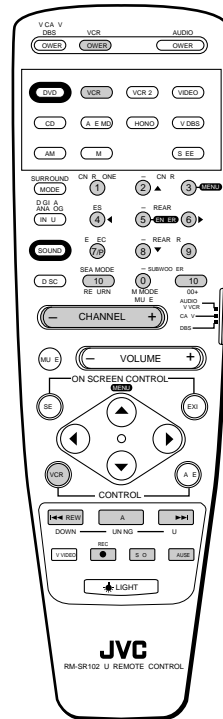

Notes:

- You can use either the VCR1 button or the VCR1 CONTROL button to activate the buttons listed to the left. If you press VCR1, the playing source also changes. On the other hand, if you press VCR1 CONTROL, the playing source does not change.
- Refer also to the manual supplied with your VCR.

Operating Other Manufactures' Components

Manufacturers' codes for TV

Admiral	093
Aiko	092
Akai	030
Alaron	179
Anam	180
Anam National	055
AOC	019, 030
Audiovox	180
Belcor	019
Bell & Howell	016, 154
Bradford	180
Brockwood	019
Candle	030, 056
Carnivale	030
Carver	054
Celebrity	000
Citizen	030, 039, 056, 060, 092, 280
Concerto	056
Contec	180
Craig	180
Crown	039, 180
Curtis Mathes	030, 039, 060, 154
CXC	180
Daewoo	019, 039, 092, 451
Daytron	019
Denon	145
Dumont	017, 019
Electroband	000
Emerson	019, 039, 154, 178, 179, 180, 236, 280, 282, 463
Envision	030
Fisher	154, 159
Fujitsu	179
Funai	171, 179, 180
Futuretech	180
GE	021, 047, 051, 055, 178, 282, 451
Gibralter	017, 019, 030
GoldStar	019, 030, 039, 178
Grunpy	179, 180
Hallmark	178
Harvard	180
Hitachi	056, 145, 151
Infinity	054
JBL	054
JCB	000
JVC	053, 069, 160, 169
KEC	180
Kenwood	019, 030
KTV	030, 039, 180, 280
Logik	016
Luxman	056
LXI	047, 054, 154, 156, 178
Magnavox	030, 054, 187
Majestic	016
Marantz	030, 054
Matsushita	250
Megatron	145, 178
Memorex	016, 056, 150, 154, 178
MGA	019, 030, 150, 178
Midland	017, 039, 047, 051
Minutz	021
Mitsubishi	019, 093, 150, 178
Motorola	055, 093
MTC	019, 030, 056, 060
Multitech	180
NAD	156, 166, 178
NEC	019, 030, 056
Nikko	030, 092, 178

Noshi	018
NTC	092
Onwa	180
Optimus	154, 166, 250
Optonica	093, 165
Orion	236
Panasonic	051, 055, 250
Penney	018, 019, 021, 030, 039, 047, 051, 060, 156, 178
Philco	019, 030, 054
Philips	054
Pilot	019, 030, 039
Pioneer	166
Portland	019, 039, 092
Prism	051
Proscan	047
Proton	178
Pulsar	017, 019
Quasar	051, 055, 165, 250
Radio Shack	019, 030, 039, 047, 056, 154, 165, 178, 180
RCA	018, 019, 047, 090
Realistic	019, 030, 039, 056, 154, 165, 178, 180
Runco	017, 030
Sampo	030, 039
Samsung	019, 030, 039, 056, 060, 178
Samsux	039
Sansei	451
Sanyo	154, 159
Scimitsu	019
Scotch	178
Scott	019, 178, 179, 180, 236
Sears	047, 054, 056, 154, 156, 159, 171, 178, 179
Sharp	039, 093, 165
Shogun	019
Signature	016
Simpson	187
Sony	000
Soundesign	178, 179, 180
Squareview	171
SSS	019, 180
Starlite	180
Supreme	000
Sylvania	030, 054
Symphonic	171
Tandy	093
Tatung	055
Technics	051, 250
Technol Ace	179
Techwood	051, 056
Teknika	016, 019, 039, 054, 056, 060, 092, 150, 179, 180
TMK	056, 178
Telefunken	056
Toshiba	060, 154, 156
Totevision	039
Vector Research	030
Victor	053
Vidikron	054
Vidtech	019, 178
Wards	016, 019, 021, 030, 054, 056, 165, 178, 179
Yamaha	019, 030
Zenith	016, 017

Manufacturers' codes for CATV converters

ABC	003, 007, 008, 011, 013, 014, 017
Allegro	153
Archer	153
Century	153
Citizen	153
Comtronics	040
Contec	019
Everquest	015, 040
Focus	400
Garrard	153
Gemini	015
General Instrument	011, 276
GoldStar	040, 144
Hamlin	009, 020, 259, 273
Hitachi	011
Hytex	007
Jasco	153
Jerrold	003, 011, 012, 014, 015, 276
Memorex	000
Oak	007, 019
Optimus	021
Panasonic	000, 021
Paragon	000
Philips	153
Pioneer	144
Popular Mechanics	400
Pulsar	000
Radio Shack	015
RCA	021
Recoton	400
Regal	020, 259, 273
Rembrandt	011
Runco	000
Samsung	040, 144
Scientific Atlanta	008, 017, 277
Signal	015, 040
Signature	011
SL Marx	040
Sprucer	021
Starcom	003, 015
Stargate	015, 040
Starquest	015
Televue	040
Tocom	012, 013
Toshiba	000
Tusa	015
Unika	153
United Artists	007
United Cable	003
Universal	153
Zenith	000
Zentek	400

Manufacturers' codes for DBS tuner

AlphaStar	772
Echostar	775
HTS	775
Hitachi	819
Hughes Network Systems	749
Jerrold	627
Panasonic	701
Primestar	627
RCA	566
Sony	639

Manufacturers' codes for VCR

Admiral	048
Adventura	000
Aiko	278
Aiwa	000, 037
Akai	041
American High	035
Asha	240
Audiovox	037
Beaumarck	240
Bell & Howell	104
Broksonic	121, 184, 211
Calix	037
Canon	035
Capehart	020
Carver	081
CCE	072, 278
Citizen	037, 278
Colt	072
Craig	037, 047, 072, 240
Curtis Mathes	035, 041, 060
Cybernex	240
Daewoo	020, 045, 278
Daytron	020
Denon	042
Dynatech	000
Electrohome	037
Electroponic	037
Emerex	032
Emerson	000, 002, 037, 043, 121, 184, 209, 211, 212, 278, 479
Fisher	047, 054, 104
Fuji	033, 035
Funai	000
Garrard	000
GE	035, 060
GoldStar	037, 038
Gradiente	000
Harley Davidson	000
Harman/Kardon	038
Harwood	072
Headquarter	046
HI-Q	047
Hitachi	041, 042
Jensen	041
JVC	008, 041, 067
KEC	037, 278
Kenwood	038, 041, 067
KLH	072
Kodak	035, 037
Lloyd's	000
Logik	072
LXI	037
Magnavox	035, 039, 081, 149
Magnin	240
Marantz	035, 081
Marta	037
Matsushita	035, 162
MEI	035
Memorex	000, 035, 037, 039, 046, 047, 048, 104, 240
MGA	043
MGN Technology	240
Minolta	042
Mitsubishi	043, 067
Motorola	035, 048
MTC	000, 240
Multitech	000, 072

Operating Other Manufactures' Components ---

NEC	038, 041, 067, 104
Nikko	037
Nikon	034
Noblex	240
Olympus	035
Optimus	037, 048, 104, 162
Orion	479
Panasonic	035, 162, 225
Penney	035, 037, 038, 042, 054, 240
Pentax	042
Philco	035
Philips	035, 081
Pilot	037
Pioneer	067
Portland	020
Profitronic	240
Protec	072
Pulsar	039
Quarter	046
Quartz	046
Quasar	035, 162
Radio Shack	000, 037
Radix	037
Randex	037
RCA	042, 060, 149
Realistic	000, 035, 037, 046, 047, 048, 104
Ricoh	034
Runco	039
Samsung	045, 240
Sanky	039, 048
Sansui	041, 067
Sanyo	046, 047, 104, 240
Scott	043, 045, 121, 184, 211, 212
Sears	035, 037, 042, 046, 047, 054, 104
Sharp	048
Shintom	072
Shogun	240
Singer	072
Sony	032, 033, 034, 035
STS	042
Sylvania	000, 035, 043, 081
Symphonic	000
Tatung	041
Teac	000, 041
Technics	035, 162
Teknika	000, 035, 037
TMK	240
Toshiba	043, 045, 212
Totevision	037, 240
Unitech	240
Vector	045
Vector Research	038
Video Concepts	045
Videosonic	240
Wards	000, 035, 042, 047, 048, 060, 072, 081, 149, 212, 240
XR-1000	000, 035, 072
Yamaha	038
Zenith	033, 034, 039

Manufacturers' codes listed on page 65 to 67 are subject to change without notice. If they are changed, this remote control cannot operate the equipment.

Troubleshooting

Use this chart to help you solve daily operational problems. If there is any problem you cannot solve, contact your JVC service center.

PROBLEM	POSSIBLE CAUSE	SOLUTION
The display does not light up.	The power cord is not plugged in.	Plug the power cord into an AC outlet.
No sound from speakers.	Speaker signal cables are not connected.	Check speaker wiring and reconnect if necessary.
	The SPEAKERS 1 and 2 buttons are not set correctly.	Press SPEAKERS 1 and 2 correctly.
	An incorrect source is selected.	Select the correct source.
	Muting is activated.	Press MUTE to cancel the mute.
Sound from one speaker only.	Speaker signal cables are not connected properly.	Check speaker wiring and reconnect if necessary.
	The balance is set to one extreme.	Adjust the balance properly (see page 18).
Continuous hiss or buzzing during FM reception.	Incoming signal is too weak.	Connect an outside FM antenna or contact your dealer.
	The station is too far away.	Select a new station.
	An incorrect antenna is used.	Check with your dealer to be sure you have the correct antenna.
	Antennas are not connected properly.	Check connections.
Occasional cracking noise during FM reception.	Ignition noise from automobiles.	Move the antenna farther from automobile traffic.
Howling during record playing.	Your turntable is too close to speakers.	Move speakers away from the turntable.
"OVERLOAD" starts flashing on the display.	Speakers are overloaded because of high volume.	Rotate the MASTER VOLUME control counterclockwise three or four times then press POWER on the front panel. If "OVERLOAD" does not disappear, unplug the AC power cord, then plug it back again.
	Speakers are overloaded because of short circuit of speaker terminals.	Press POWER on the front panel then check the speaker wiring. If "OVERLOAD" does not disappear, unplug the AC power cord, then plug it back again. If speaker wiring is not short-circuited, contact your dealer.
Remote control does not work.	The remote control mode selector is not set correctly.	Set the selector correctly either to "AUDIO/TV/VCR," "CATV" or "DBS."
	There is an obstruction in front of the remote sensor on the receiver.	Remove the obstruction.
	Batteries are weak.	Replace batteries.

Specifications

Output Power At Stereo operation 130 watts per channel, min. RMS, both channels driven into 8 ohms, 20 Hz to 20 kHz with no more than 0.02% total harmonic distortion.

Amplifier

Output Power	At Surround operation	
	Front Channels	100 watts per channel, min. RMS, driven into 8 ohms at 1 kHz with no more than 0.8% total harmonic distortion.
	Center channel	100 watts, min. RMS, driven into 8 ohms at 1 kHz, with no more than 0.8% total harmonic distortion.
	Rear channels	100 watts per channel, min. RMS, driven into 8 ohms at 1kHz, with no more than 0.8% total harmonic distortion.
Total Harmonic Distortion (8 ohms, 1 kHz)		0.02%* at 130 watts output (* Measured by JVC Audio Analysis System)
Audio Input Sensitivity/Impedance (1 kHz)	PHONO (MM)	2.5 mV/47 k ohms
	CD, TAPE/MD, TV SOUND/DBS, VCR1, VCR2, VIDEO, DVD	200 mV/47 k ohms
Audio Input (DIGITAL IN)	Coaxial: DIGITAL 1 (DBS)	0.5 Vp-p/75 ohms
	Optical: DIGITAL 2 (DVD), DIGITAL 3 (CD)	-21 dBm to -15 dBm (660 nm ±30 nm)
Audio Output Level	TAPE/MD, VCR1, VCR2	200 mV
	PRE OUT (FRONT)	1V
Signal-to-Noise Ratio ('66 IHF/'78 IHF)	PHONO	70 dB/78 dB (at REC OUT)
	CD, TAPE/MD, TV SOUND/DBS, VCR1, VCR2, VIDEO, DVD	87 dB/80 dB
Frequency Response (8 ohms)	PHONO	20 Hz to 20 kHz (±1 dB)
	CD, TAPE/MD, TV SOUND/DBS, VCR1, VCR2, VIDEO, DVD	20 Hz to 20 kHz (±1 dB)
RIAA Phono Equalization		±0.5 dB (20 Hz to 20 kHz)
Loudness Control (Volume Control at -30 dB)		+6 ±1 dB at 100 Hz +4 ±1 dB at 10 kHz
S.E.A.	Center Frequencies	100 Hz, 1 kHz, 10 kHz
	Control Range	±10 dB ±2 dB

Video

Video Input Sensitivity/Impedance	Composite video: TV SOUND/DBS, VCR1, VCR2, VIDEO, DVD	1 Vp-p/75 ohms
	S-video: TV SOUND/DBS, VCR1, VIDEO, DVD	
	(Y: luminance):	1 Vp-p/75 ohms
	(C: chrominance, burst):	0.286 Vp-p/75 ohms
Video Output Level	Composite video: VCR1, VCR2, MONITOR OUT ...	1 Vp-p/75 ohms
	S-video: VCR1, MONITOR OUT	1 Vp-p/75 ohms
	(Y: luminance):	1 Vp-p/75 ohms
	(C: chrominance, burst):	0.286 Vp-p/75 ohms

Synchronization	Negative
Signal-to-Noise Ratio	45 dB
On-Screen Color System	NTSC

FM tuner (IHF)

Tuning Range	87.5 MHz to 108.0 MHz
Usable Sensitivity	Monaural 10.8 dBf (0.95 μ V/75 ohms)
50 dB Quieting Sensitivity	Monaural 16.3 dBf (1.8 μ V/75 ohms) Stereo 38.3 dBf (22.5 μ V/75 ohms)
Signal-to-Noise Ratio	Monaural 80 dB at 85 dBf (IHF-A weighted) Stereo 73 dB at 85 dBf
Total Harmonic Distortion	Monaural 0.15 % at 1 kHz Stereo 0.2 % at 1 kHz
Stereo Separation at REC OUT	40 dB at 1 kHz
Capture Ratio	1.5 dB at 85 dBf
Alternate Channel Selectivity	60 dB: (\pm 400 kHz)
Frequency Response	30 Hz to 15 kHz: (+0.5 dB, -3 dB)

AM tuner

Tuning Range	530 kHz to 1,710 kHz
Usable Sensitivity	Loop antenna 300 μ V/m
Signal-to-Noise Ratio	50 dB (100 mV/m)

General

Power Requirements	AC 120V \sim , 60 Hz
Power Consumption	310 watts/410 VA 2 watts (in standby mode)
Dimensions (W x H x D)	17 $\frac{3}{16}$ x 6 $\frac{3}{16}$ x 16 $\frac{1}{4}$ inches (435 x 157 x 412.5 mm)
Mass	26.3 lbs (11.9 kg)

Designs & specifications are subject to change without notice.

HOW TO LOCATE YOUR JVC SERVICE CENTER

TOLL FREE : 1-800-537-5722

Dear customer:

In order to receive the most satisfaction from your purchase, read the instruction booklet before operating the unit. In the event that repair is necessary, or for the address nearest your location, please refer to the factory service center list below or within the Continental United States, Call 1-800-537—5722 for your authorized servicer. Remember to retain you Bill of Sale for Warranty Service.

—JVC

**JVC SERVICE & ENGINEERING
COMPANY OF AMERICA
DIVISION OF US JVC CORP.**

FACTORY SERVICE CENTER LOCATIONS

107 Little Falls Road
Fairfield, NJ 07004-2105
(201) 808-9279

1500 Lakes Parkway
Lawrenceville, GA 30243-5357
(404) 339-2522

705 Enterprise Street
Aurora, IL 60504-8149
(708) 851-7855

5665 Corporate Avenue
Cypress, CA 90630-0024
(714) 229-8011

2969 Mapunapuna Place
Honolulu, HI 96819-2040
(808) 833-5828

10700 Hammerly, Suite 110
Houston, TX 77043
(713) 935-9331

230 Eliot Street
Ashland, MA 0172-2377
(508) 881-5923

14505 Commerce Way
Miami Lakes, FL 33016-1512
(305) 362-6252

890 Dubuque Avenue
South San Francisco, CA 94080-1804
(415) 871-2666

Sophisticated electronic products may require occasional service. Just as quality is a keyword in the engineering and production of the wide array of JVC products, service is the key to maintaining the high level of performance for which JVC is world famous. The JVC service and engineering organization stands behind our products.

NATIONAL HEADQUARTERS
JVC SERVICE & ENGINEERING COMPANY OF AMERICA
DIVISION OF US JVC CORP.
107 Little Falls Road
Fairfield, NJ 07004-2105

If you ship the product •••

Pack your JVC unit in the original carton or one of equivalent size and strength. Enclose, with the unit, a letter stating the problem or symptom that exists and also a copy of the receipt or bill of sale you received when you purchased your JVC unit. Print your home return address on the outside and the inside of the carton. Send to the appropriate JVC Factory Service Center as listed above.

Don't service it yourself.

CAUTION

*To prevent electrical shock, do not open the cabinet. No user serviceable parts inside.
Refer servicing to qualified service personnel.*

ACCESSORIES

*To purchase accessories for your JVC product, you may contact your local JVC Dealer.
Or from the 48 Continental United States call toll free : 800-882-2345*



LIMITED WARRANTY AUDIO-2

JVC COMPANY OF AMERICA warrants this product and all parts thereof, except as set forth below ONLY TO THE ORIGINAL PURCHASER AT RETAIL to be FREE FROM DEFECTIVE MATERIAL AND WORKMANSHIP from the date of original retail purchase for the period as shown below. ("The Warranty Period.")

PARTS 2 YRS	LABOR 2 YRS
----------------	----------------

THIS LIMITED WARRANTY IS VALID ONLY IN THE FIFTY(50) UNITED STATES, THE DISTRICT OF COLUMBIA AND IN COMMONWEALTH OF PUERTO RICO.

WHAT WE WILL DO:

If this product is found to be defective, JVC will repair or replace defective parts at no charge to the original owner. Such repair and replacement services shall be rendered by JVC during normal business hours at JVC authorized service centers. Parts used for replacement are warranted only for the remainder of the Warranty Period. All products and parts thereof may be brought to a JVC authorized service center on a carry-in basis except for Television sets having a screen size 25 inches and above which are covered on an in-home basis.

WHAT YOU MUST DO FOR WARRANTY SERVICE:

Return your product to a JVC authorized service center with a copy of your bill of sale. For your nearest JVC authorized service center, please call toll free: (800)537-5722. If service is not available locally, box the product carefully, preferably in the original carton, and ship, insured, with a copy of your bill of sale plus and letter of explanation of the problem to the nearest JVC Factory Service Center, the name and location of which will be given to you by the toll-free number. If you have any questions concerning your JVC Product, please contact our Customer Relations Department.

WHAT IS NOT COVERED:

This limited warranty provided by JVC does not cover:

1. Products which have been subject to abuse, accident, alteration, modification, tampering, negligence, misuse, faulty installation, lack of reasonable care, or if repaired or serviced by anyone other than a service facility authorized by JVC to render such service, or if affixed to any attachment not provided with the products, or if the model or serial number has been altered, tampered with, defaced or removed;
2. Initial installation and installation and removal for repair;
3. Operational adjustments covered in the Owner's Manual, normal maintenance, video and audio head cleaning;
4. Damage that occurs in shipment, due to act of God, and cosmetic damage;
5. Signal reception problems and failures due to line power surge;
6. Video Pick-up Tubes/CCD Image Sensor, Cartridge, Stylus(Needle) are covered for 90 days from the date of purchase;
7. Accessories;
8. Batteries (except the Rechargeable Batteries are covered for 90 days from the date of purchase);

There are no express warranties except as listed above.

THE DURATION OF ANY IMPLIED WARRANTIES, INCLUDING THE IMPLIED WARRANTY OF MERCHANTABILITY, IS LIMITED TO THE DURATION OF THE EXPRESS WARRANTY HEREIN.

JVC SHALL NOT BE LIABLE FOR THE LOSS OF USE THE PRODUCT, INCONVENIENCE, LOSS OR ANY OTHER DAMAGES, WHETHER DIRECT, INCIDENTAL OR CONSEQUENTIAL (INCLUDING, WITHOUT LIMITATION, DAMAGE TO TAPES, RECORDS OR DISCS) RESULTING FROM THE USE OF THIS PRODUCT, OR ARISING OUT OF ANY BREACH OF THIS WARRANTY. ALL EXPRESS AND IMPLIED WARRANTIES, INCLUDING THE WARRANTIES OF MERCHANTABILITY AND FITNESS FOR PARTICULAR PURPOSE, ARE LIMITED TO THE WARRANTY PERIOD SET FORTH ABOVE.

Some states do not allow the exclusion of incidental or consequential damages or limitations on how long an implied warranty last, so these limitations or exclusions may not apply to you. This warranty gives you specific legal rights and you may also have other rights which vary from state to state.

JVC COMPANY OF AMERICA
DIVISION OF US JVC CORP.

41 Slater Drive
Elmwood Park, New Jersey 07407

REFURBISHED PRODUCTS CARRY A SEPARATE WARRANTY, THIS WARRANTY **DOES NOT** APPLY. FOR DETAILS OF REFURBISHED PRODUCT WARRANTY, PLEASE REFER TO THE REFURBISHED PRODUCT WARRANTY INFORMATION PACKAGED WITH EACH REFURBISHED PRODUCT.

For customer use:

Enter below the Model No. and Serial No. which is located either on the rear, bottom or side of the cabinet. Retain this information for future reference.

Model No.: _____

Serial No.: _____

Purchase date: _____

Name of dealer: _____

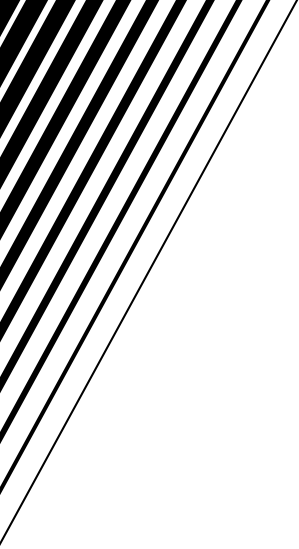

JVC
VICTOR COMPANY OF JAPAN, LIMITED